



Warranty Registration Form

Free gift with completion of form

To be completed and mailed or faxed by the customer purchasing equipment.
Return this warranty card within ten days of purchase.

Purchased By:

Name _____ Title _____

Company _____

Street Address _____

City _____ State _____ Zip Code _____

Phone Number _____ Fax _____

Date Purchased _____ Name of Distributor _____

KaiVac® KaiZen™
Serial Number _____

Does your system include a KaiTutor™? Yes No

Type of Business

- | | |
|---|--------------------------------------|
| <input type="checkbox"/> School/University | <input type="checkbox"/> Industrial |
| <input type="checkbox"/> Hospital/Health Care | <input type="checkbox"/> Office |
| <input type="checkbox"/> Contract Cleaner | <input type="checkbox"/> Other _____ |

Intended Uses (check all that apply):

- | | | |
|--|--|---|
| <input type="checkbox"/> Restroom Cleaning | <input type="checkbox"/> Cleaning Around Machinery | <input type="checkbox"/> Classroom Cleaning |
| <input type="checkbox"/> Floor Stripping | <input type="checkbox"/> Stairwell Cleaning | <input type="checkbox"/> Other _____ |
| <input type="checkbox"/> Kitchen Cleaning | <input type="checkbox"/> Locker and Shower Room | |
| <input type="checkbox"/> Carpet Extraction | <input type="checkbox"/> Hallway Cleaning | |

Thank you very much for the information you have filled out for our records. As our way of saying thank you, we'd like to send you a free Microfiber KaiTowel.

Kaivac, Inc. · 401 South Third St. · Hamilton, Ohio 45011
Phone (513) 887-4600 · Fax (513) 887-4601 · Toll Free (800) 287-1136 · www.kaivac.com



Certificate of Conformity

We **Kaivac, Inc.**
401 S. Third Street
Hamilton, OH 45011 USA

Declare and Certify that the following product

| | |
|---------------------|--|
| Machine | |
| Type/Model | |
| Serial Number | |
| Date of Manufacture | |

Has been manufactured using the following standards and specifications:

And has been inspected and tested at our works in accordance with the relative specifications and drawings with which they comply in all respects:

And has been affixed with the CE Mark in Compliance with the following standards and specifications:

BS EN 292-1:1991 Safety of Machinery - Basic concepts, general principles for design. Part 1: Basic terminology, methodology.

BS EN 292-2:1991 Safety of Machinery - Basic concepts, general principles of design - Part 2: Technical principles and specifications.

BS EN 614-1:1995 Safety of Machinery - Ergonomic design principles - Part 1: Terminology and general principles.

BS EN 1050:1996 Safety of Machinery - Principles for risk assessment

BS EN 60204-1:1993 Safety of Machinery - Electrical equipment of machines - Part 1: Specification for general requirements.

and complies with the requirements of:

European Machinery directive 98/37/EC

UK Regulation 1992 no. 3073 - Supply of Machinery (Safety) Regulations 1992, and as amended.

European Low Voltage Directive 73/23/EC and as amended by 93/68/EC.

UK Regulation 1994 no.3260 - Electrical Equipment (Safety) Regulations 1994.

| | |
|----------------|---|
| Place of Issue | 401 S. Third Street, Hamilton, OH 45011 USA |
| Date of Issue | |
| Signature | |
| Printed Name | |
| Position | Quality Manager |

Filter Screen Cleaning Procedure

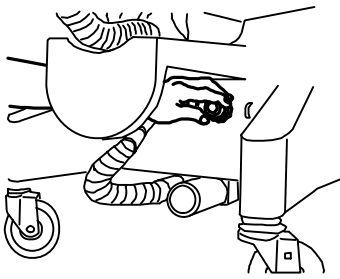

KaiVac filter is located on the base below the vac hose wrap on front of machine.

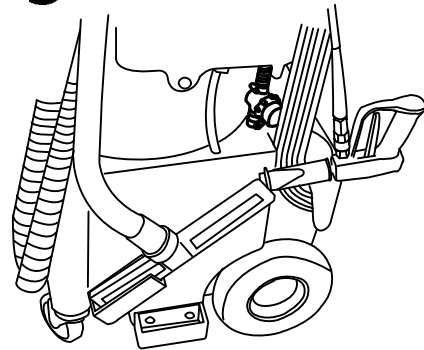

KaiZen filter is located on the left side of machine between water supply tank and the hood assembly.

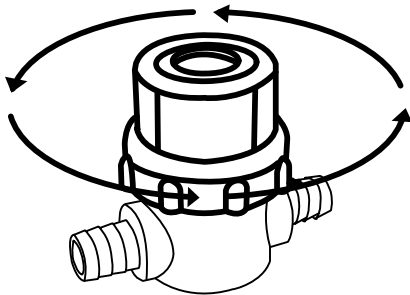

Rotate bowl cover counterclockwise to remove.

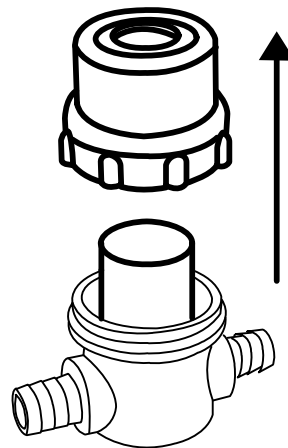

Lift bowl cover up and remove.

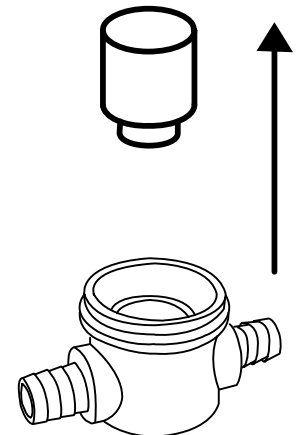

Pull filter up and out.

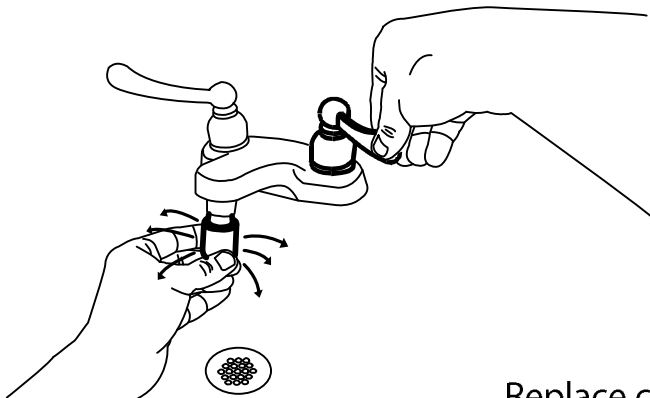

Place filter screen with the open end up against spout of sink fixture or water source and turn on the water flushing debris from the inside out. Continue flushing until water flows freely thru filter. Filter is clean if one can blow freely thru it.

Replace cleaned filter reversing the procedure above. If filter cannot be cleaned replace with new one.

DO NOT OPERATE MACHINE WITHOUT FILTER.

Winterize your Kaivac Equipment

Your Kaivac machinery should be winterized between uses if it is to be exposed to freezing temperatures. To winterize your machine, pour 1/2 gallon of windshield wiper fluid into the empty water tank. Aim the spray gun into the water tank. Run the pump and spray the gun until the fluid begins running through.



KaiVac Operator's Manual

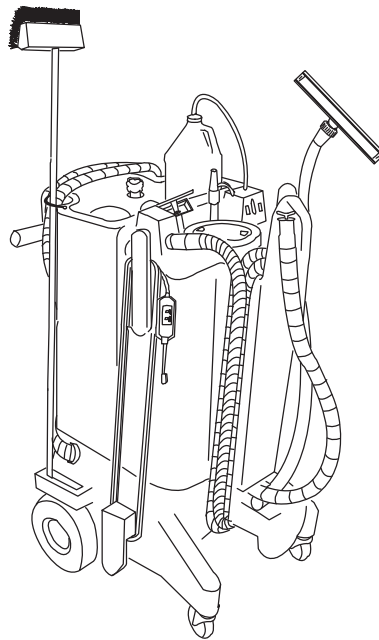

Serial Number:

Date of Purchase:

Source of Purchase (Distributor):

KaiVac Incorporated
401 South Third Street
Hamilton, Ohio 45011
phone: 800-287-1136
fax: 513-887-4601
kaivac.com

READ THIS MANUAL CAREFULLY BEFORE OPERATING THE KAIKAC
CLEANING SYSTEM

TABLE OF CONTENTS

SECTION 1

| | |
|------------|----------------------------------|
| 1..... | Introduction |
| 2-3..... | Safety Precautions |
| 4..... | Limited Warranty Protection Plan |
| 5-16..... | S.I.M.P.L.E Operation |
| 17..... | Optional Uses |
| 18..... | Chemical Injection Chart |
| 19..... | Routine Maintenance |
| 20-22..... | Trouble Shooting Guide |
| 24..... | Water Airflow Schematic |
| 25..... | Wiring Diagram |

SECTION 2

| | |
|----------------|---------------------------------|
| 1-2-3-4-5..... | Parts list |
| 6..... | External View |
| 7..... | Internal View |
| 8..... | CVS12 Squeegee Tool |
| | SUBEB2001 Electrical Box |
| 9..... | SUBGA Gun Assem. |
| | SUBFL Float Shutoff |
| 10..... | SUBSP Standpipe |
| | Water Filters |
| 11..... | SUBIQD Chemical Injector |
| | SUBWHR Water return / T Connect |
| 12..... | SUBPA Pump Motor Assem |
| | Unloader Check Valve |
| 13..... | SUBCE Carpet Extractor |
| | KAIMOP |
| 14..... | Upholstery Tool |
| | Muffler |



SECTION 1

Introduction

INSPECTION

Carefully unpack and inspect your new KaiVac cleaning machine for shipping damage. Each unit is tested and thoroughly inspected before shipping. For instructions regarding any shipping damage, contact KaiVac immediately. All returns must have a Return Authorization Number (RAN).

WARNINGS

- **DO NOT** operate with a frayed, worn or damaged cord.
- **DO NOT** use to pick up flammable or combustible materials.
- **DO NOT** run the pump without water in the water tank.
- **DO NOT** use hot water.

GROUNDING INSTRUCTIONS

THE KAI VAC MUST BE GROUNDED. If it should malfunction or stop working, grounding provides a path of least resistance for electrical current, thereby reducing the risk of electrical shock. The KaiVac is also supplied with a ground fault circuit interruptor (GFCI) to reduce danger of electric shock. It must be maintained and tested regularly. This unit is equipped with a cord that has an equipment grounding conductor and a grounding plug. The plug must be inserted in an appropriate outlet that is properly installed and grounded in accordance with all local codes and ordinances. Cutting off the ground wire or using a cord that is not equipped with a ground plug will void the warranty on the unit, and KaiVac will accept NO responsibility associated with the unit.

Improper connection of the equipment grounding connector conductor can result in a risk of electrical shock. Check with a qualified electrician or service person if you doubt the outlet is properly grounded. Do not modify the plug provided with the KaiVac. If it will not fit the outlet, have a proper outlet installed by a qualified electrician.

Safety Precautions

- **Equipment Warning**
 - Read all instructions to ensure safe operation of the KaiVac.
- **Training**
 - Proper training is required before using the KaiVac. Contact your authorized KaiVac distributor for training information.
 - Instruction placards are attached to each KaiVac and should not be removed. These placards show proper cleaning procedures and safety precautions.
- **Equipment Use**
 - Do not use the equipment in a manner that it was not intended for by the manufacturer.
 - See S-I-M-P-L-E Operation section for proper use of the equipment.
- **Spray Gun**
 - Never point the spray gun at people.
- **Prevention of Electrocutation –**
 - Use the ground fault circuit interruptor (GFCI) with the KaiVac at all times.
 - Test the GFCI before each use.
 - Do not spray liquid from the KaiVac onto electrical outlets or on any electrical devices.
- **Personal Protection –**
 - Wear gloves, eye protection and ear protection when operating the KaiVac.
- **Prevention of Water Damage to Buildings**
 - The KaiVac is to be used on water-resistant building surfaces only. These include concrete, terrazzo, ceramic tile and quarry tile.
 - The KaiVac may be used for stripping on vinyl-composite tile floors, but daily cleaning of resilient flooring using the KaiVac is not recommended.
 - Never overflow the water tank or the vacuum recovery tank.
 - Discontinue use if any leaks occur in the KaiVac.

CAUTION: Prior to cleaning, always inspect area to ensure that the surfaces to be cleaned are water-safe. In addition, check for poor construction, damaged walls and floors, missing or damaged tiles or grout, missing or insufficient caulk, and loose wall coverings. If problems are discovered, resolve them prior to cleaning in order to avoid any harm that may result from exposure to water or cleaning solution.

- **Chemical Use**

- Only use chemicals approved for use with the KaiVac. Use of non-Kaivac Will reduce warranty and may cause machine damage.
- Turn Chemical line off when not in use.
- Keep the appropriate chemical MSDS sheets on hand at all times.
- Cleaning chemicals should not be put in the water tank (with the exception of KaiDri in small amounts). Cleaning chemicals in the water tank can cause operator harm and machine damage because of the following:
 - Chemicals in the water tank must pass through the pump which may cause premature pump failure. Use of chemicals in the water tank voids the warranty.
 - Chemicals in the water tank will be aerosolized and may harm the operator.

- **Electrical**

- Do not pull the KaiVac by the cord or use the cord as a handle. Do not close a door on the cord or pull the cord around sharp edges or corners. Do not run over the cord. Keep the cord away from heated surfaces.
- DO NOT pull on the cord to unplug. Grasp the plug at the outlet and pull.
- Turn off the unit before unplugging.
- Connect to a properly grounded outlet only.

- **Machine Integrity**

- Do not run the pump dry. This will void the machine warranty.
- Do not run hot water through the pump. This can cause pump cavitation and will void the warranty.
- Always be sure the water tank and water line filters are clear of debris. Running the pump with clogged filters can cause pump damage.
- Replace any damaged cords before use.
- Replace any damaged hoses before use.

SAVE THESE INSTRUCTIONS
Violation of any of these instructions may void any and all warranties

Limited Warranty Protection Plan

The KaiVac has been engineered and tested to provide long lasting performance. This warranty covers defects in workmanship or materials under normal use and service from the date of purchase.

Kaivac warrants the following components to be free from defects in materials and workmanship for these time periods:

1.) KaiChem Warranty for end users who use only Kaivac chemicals for the life of the machine.

- 5 years on rotationally molded parts.
- 3 years on other parts (excluding wear items)
- 1 year on labor

2.) Standard Warranty (When Kaivac chemicals not used)

- 1 year parts and labor

All Kaivac replacement parts are guaranteed for 90 days from the date of installation. Normal wear items such as wheels, hoses, seals, gaskets, cords, casters, squeegees and GFCI are excluded from warranty coverage.

All warranty claims must be accompanied by a Return Authorization Number (R.A.N.), which is available by calling the Kaivac Customer Service Department. No returns will be accepted without a R.A.N.

This warranty does not apply to return freight costs, damage or defect caused by accident, negligence, misuse, fire or repair done by anyone other than a Kaivac authorized repair center. In no event shall Kaivac, Incorporated be liable for incidental or consequential damages, or any damages to persons or property.

Please Note: Some states do not allow the exclusion or limitation of incidental or consequential damages. This warranty is in lieu of any other warranty expressed or implied, including any implied or merchantability for a particular purpose otherwise. Under no circumstances will the seller be liable for any loss, damage, expenses or consequential damages arising in connection with the use or inability to use seller's product. Kaivac, Incorporated reserves the right to make changes or improvements to its equipment without notice.



S*I*M*P*L*E No-Touch Cleaning Method

S Set-up

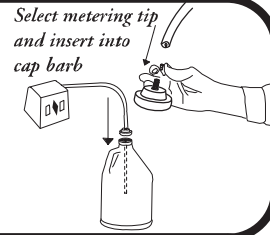
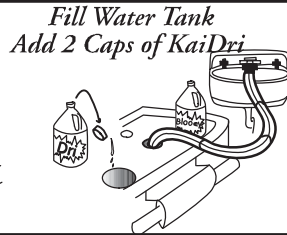

I Inject Chemicals

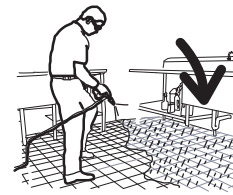
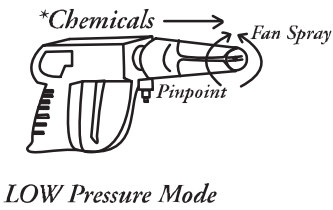

M Manual Brush (OPTIONAL)

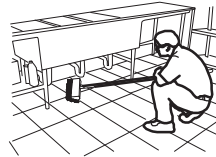
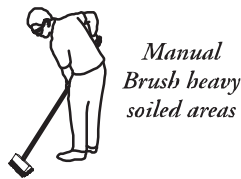

P Pressure Wash & Rinse

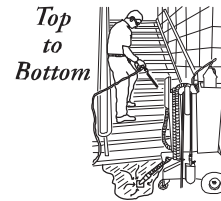
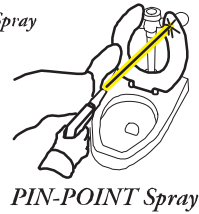
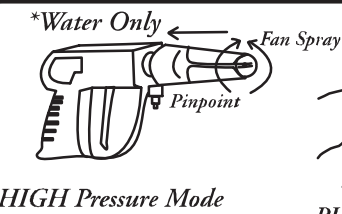

L Loop Spray Line

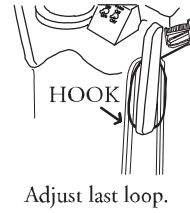

E Extract & Dry

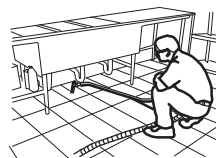



Kaivac No-Touch Restroom Cleaning

S





Turn valve on,
Check tank levels,
Optional:
Dust with KaiHose

I

Low pressure mode
Adjust spray gun to
chemical injection,
pull nozzle out and
rotate to fan pattern.

I

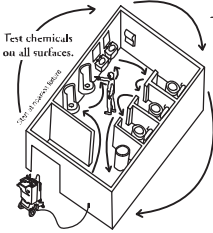
Test chemicals
on all surfaces.



Inject chemicals on fixtures and
soiled areas, start at the nearest
fixture traveling in circular pattern.

I

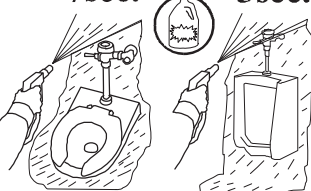
Apply cleaning
solution to fixtures.
Sinks **2sec.**

I

Turn
chemical
valve off.

I

Rinse chemical
from line onto floor.

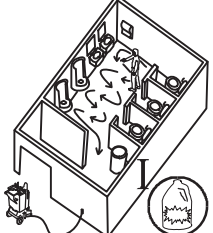
M



Optional: Manual Brush
heavily soiled floors.

P



Push nozzle in and rotate
to a pinpoint pattern.

High pressure mode
Adjust spray
gun for high
pressure wash
and rinse.

P



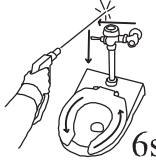

Pressure wash fixtures
in a **top to bottom**
pattern.
Sinks **7sec.**

P

Pinpoint clean
plumbing
and seat top. **6sec.**

P

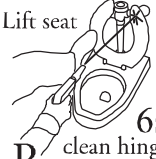
Lift seat
clean hinges
and seat
bottom. **6sec.**

P

Rim Shot
Place nozzle
under rim
and rotate. **4sec.**

P

Slam Dunk
Spray
into
bowl. **4sec.**

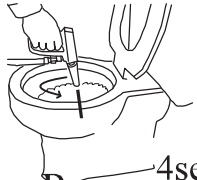
P



Spray bottom
and base. **10sec.**



Toilet Cleaning time 30sec.

L





Loop and dry
hose onto wraps.

L

HOOK
Adjust last loop.

L

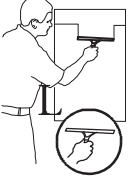
Squeegee mirrors
and flat surfaces.

L



Wet vac restroom
floor from front to rear
*Load paper and
supplies and
examine.*

E

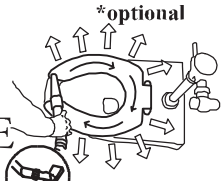
***optional**
Blow dry
flush handles
and toilet seat tops

Restroom Cleaning

Kaivac Kitchen Cleaning

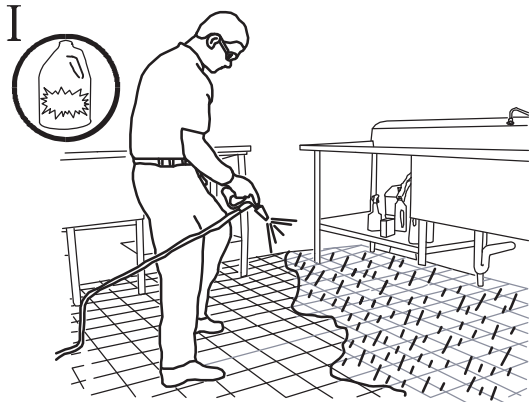
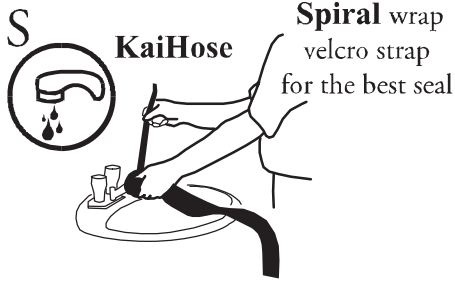

Inject chemicals on soiled surfaces and floor.

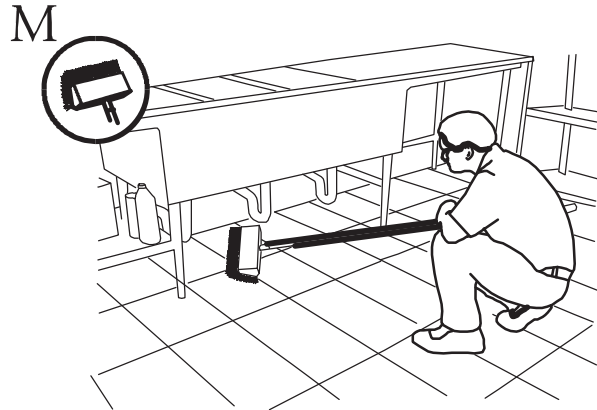

Manually brush floor in heavily soiled areas.

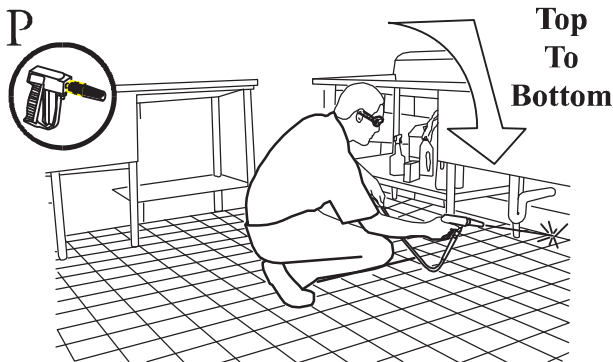

Pinpoint spray works great removing soils in corners and around base boards.

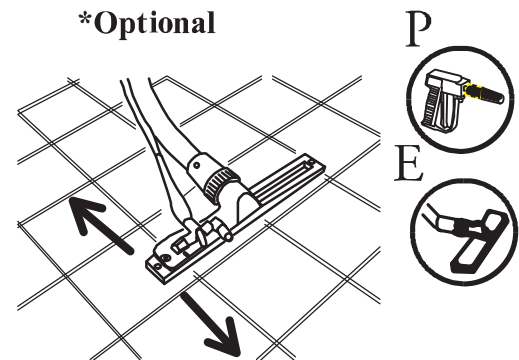

Allow degreaser proper dwell time then blast grout lines with KaiMop.

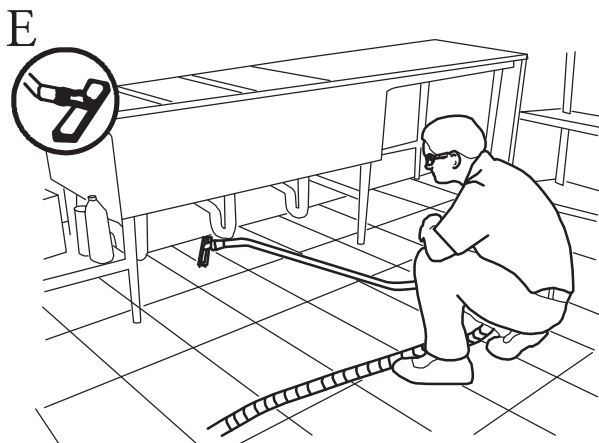

Lay Wand flat and maneuver under equipment.

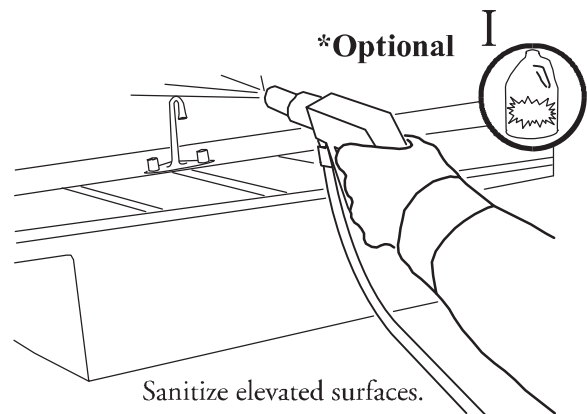

Sanitize elevated surfaces.



S*I*M*P*L*E Stairwell Cleaning



High dust cobwebs from hard to reach areas using the KaiBlower and squeegee wand



Position KaiVac at bottom of stairs with KaiDrain in position to suction excess moisture. Inject chemicals and apply to walls & stairs

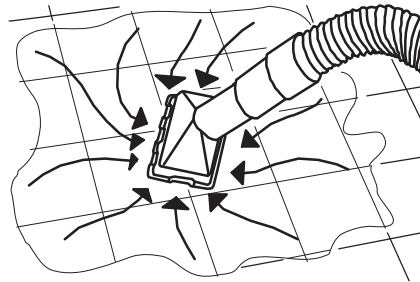

KaiDrain is an instant drain if puddling occurs

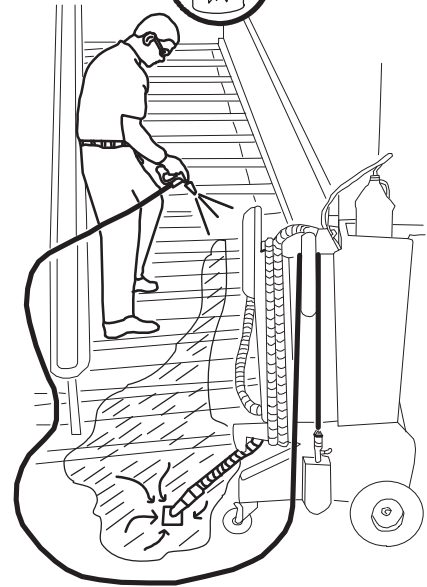

M



*** OPTIONAL**
KaiBrush walls & stairs for heavy soils.

Use the KaiGrouter or KaiMop (if available) to better control water

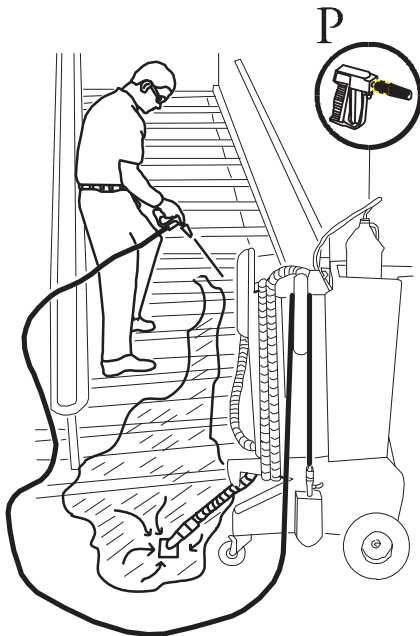

The floor squeegee tool sucks away soils and solution leaving stairway sparkling clean. Soils are contained in the KaiVac for later disposal

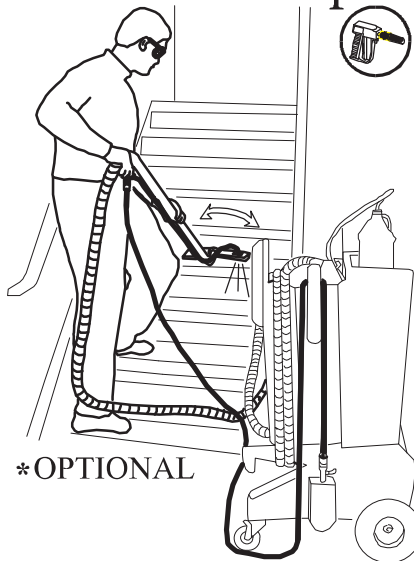

*** OPTIONAL**



Stairwell Cleaning

KaiTricks Power Prime 2001 Model (SERIAL NUMBER 3000 AND HIGHER)

NOTE: Power priming is required if the water tank has been run dry and the pump will not automatically self prime. Perform all six steps.

Fill Tank

1

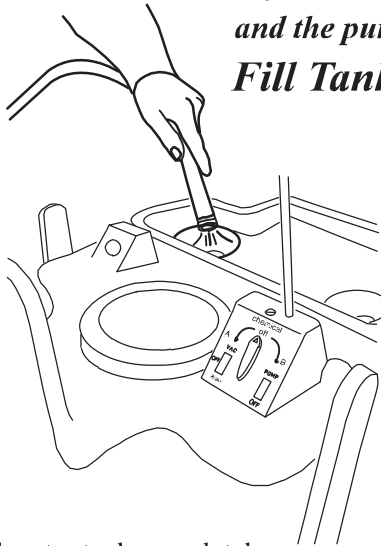

Fill water tank completely.

Turn Chemical Off

2

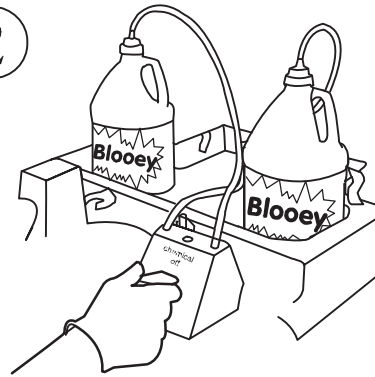

Turn chemical selector to the off position.

Disconnect Spray line

3

Disconnect the spray line at base of machine.

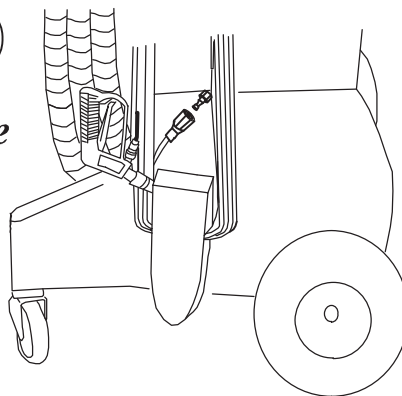

Attach Nozzle

4

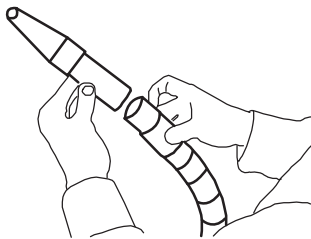

Connect the nozzle to the end of the vac hose.

Vacuum Pressure Line

5

Firmly press the vac nozzle over the pressure line fitting coming out of the base of the machine. (turn on vac and pump motor and wait for prime) Prime should occur within 1 minute.

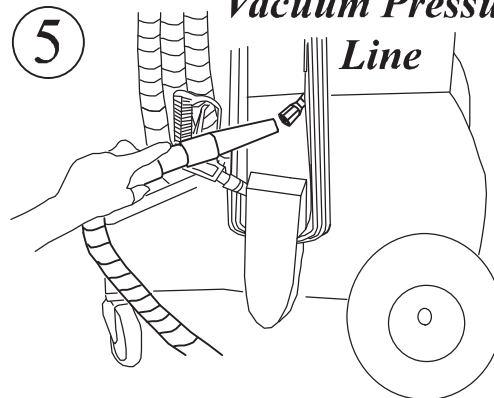

Jog (Burp) the pump

6

Continue step 5 and jog the pump motor on and off every 3 seconds, allowing the pump to come to rest each time.

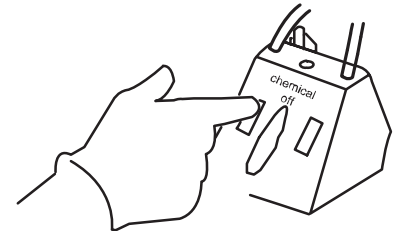

KaiTricks C

Kaivac

KaiTricks

POWER PRIME (SERIAL NUMBERS 3000 AND LESS)

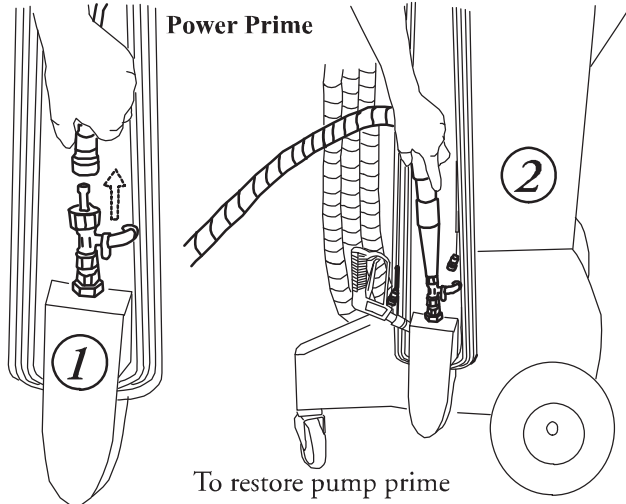

Power Prime

To restore pump prime connect blow nozzle on vacuum hose and place over injector. Hold in place until priming occurs. Reconnect spray line.



Spray proper cleaning solution on chair. Allow contact time. High pressure rinse to remove soils.

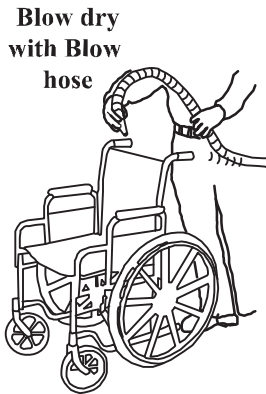

Blow dry with Blow hose



Dump KaiVac at any Toilet.

Refill the KaiVac at almost any type of sink with the KaiHose.

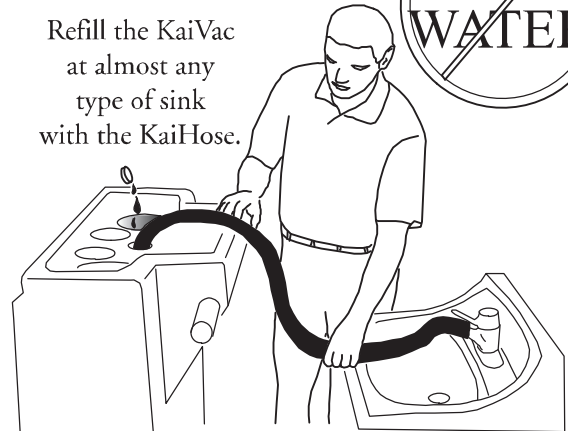

Spiral wrap velcro strap for the best seal



KaiHose

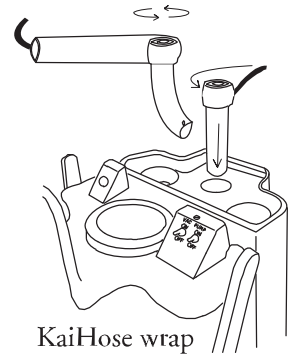

KaiHose wrap and stow

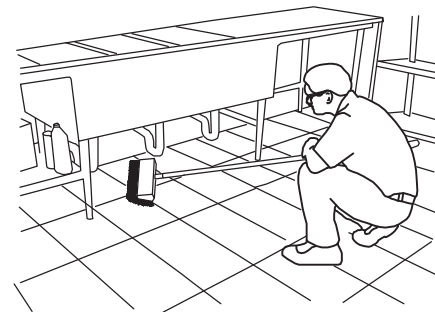

Use the KaiBrush to agitate heavy soils.



Use KaiBlower for dusting and cleaning lockers.

KaiTricks B

Kaivac

KaiTricks

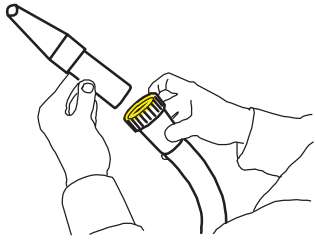

Insert KaiNozzle to blow-dust elevated areas.



High-dust cobwebs from hard to reach areas using KaiBlower and squeegee wand

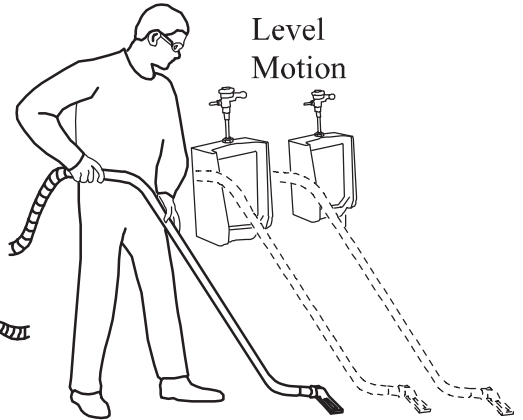

Floor squeegee works best with a level back and forward motion. Suction sound at the squeegee produces best pickups.

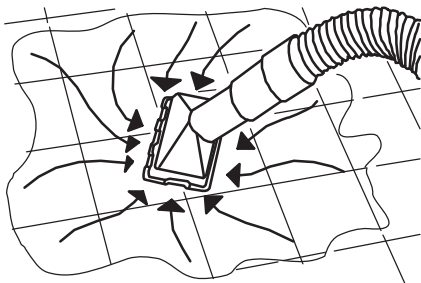

KaiDrain is an instant drain if puddling occurs.

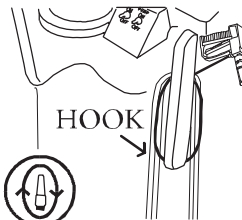

Adjust last loop.

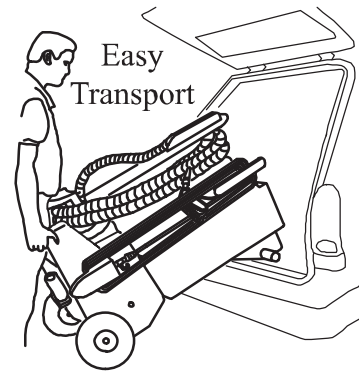

Remove Placards, Tools, Chemicals and empty tanks before loading.

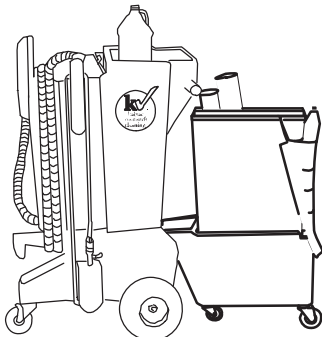

The KaiDolly carries everything you need to get the job done.



Upholstery Tool works great.

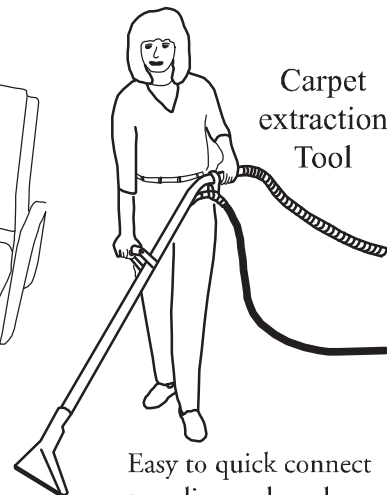

Carpet extraction Tool

Easy to quick connect spray line and vac hose.

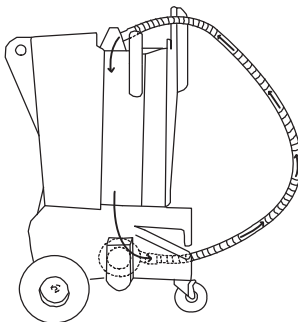

Dry vac hose by connecting hose ends to vac motor, then discharge air into vac tank.

Kaivac

Tank and Hose Cleaning

1. Unwrap vac hose and lay it on floor.
2. Suck water and air from water tank. Lower hose end to surface of water gulping both air and water. This action flushes soils from line and quickly empties water tank.

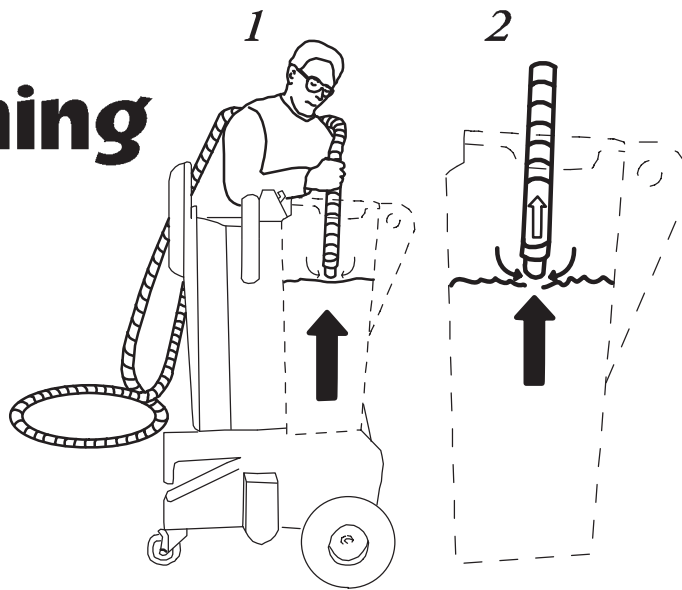

**Dry vac hose by connecting hose ends to vac motor, then discharge air into vac tank*

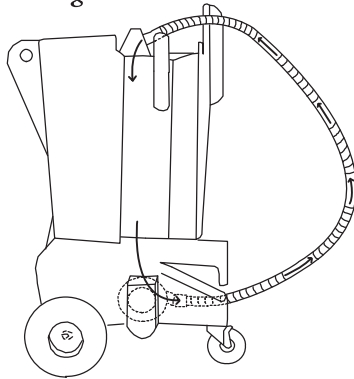

3. Vac hose can now be wrapped onto machine. Leave vac motor running while wrapping to avoid water dripping from end of hose. To completely dry hose leave vac motor running for about 3 minutes.
4. With Dump Hose opened to floor drain, spray inside of vac tank with clean water moving hose in a circular pattern to insure tank walls and float shutoff are rinsed.

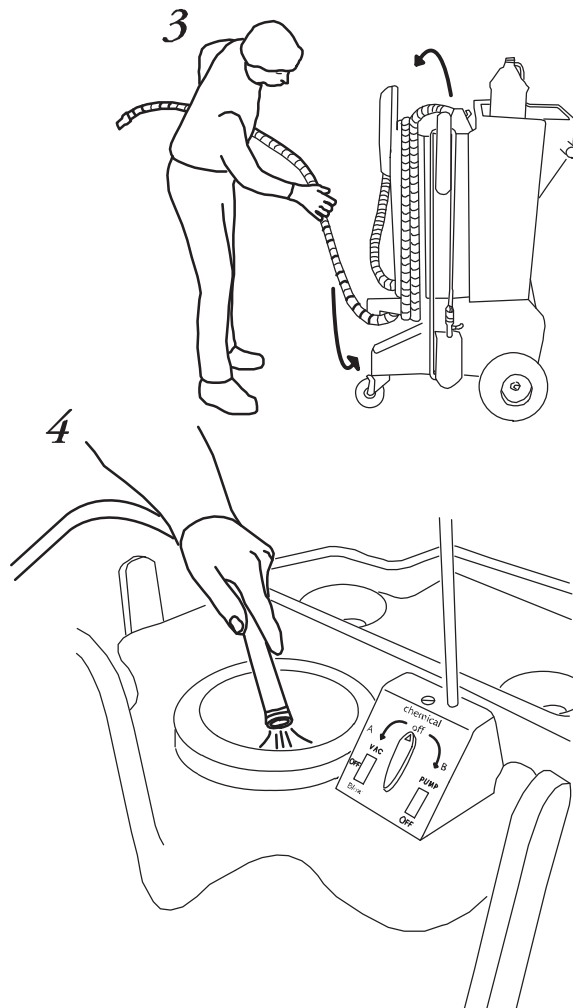

Tank and Hose Cleaning

Kaivac General Maintenance

Inspect Filters for dirt.

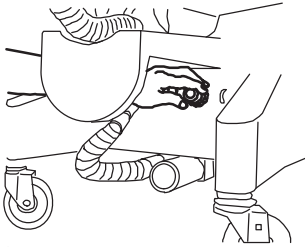

If found, remove cover, clean filter screen and reinstall.

Inspect Muffler for soils.

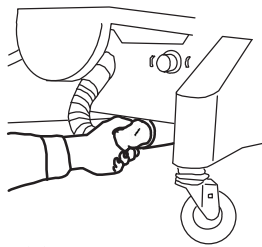

If found, remove stuffing, wash and reinstall.

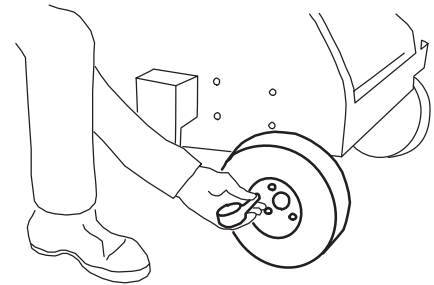

Keep tire pressure at 30 psi.

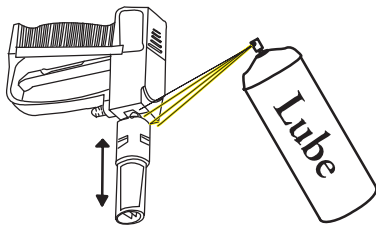

(weekly) Lubricate nozzle with penetration oil. Nozzle must move freely forward and backwards.

Windshield Fluid



Winterize KaiVac for outdoor storage or transport in sub freezing temperatures. Remove all water from tank, add 1/2 gallon windshield washer fluid. Run pump and spray until fluid is discharged from gun.

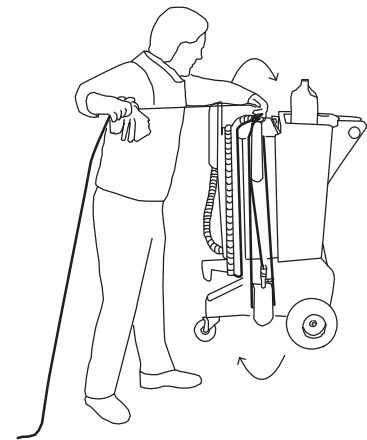

Wrap hoses and cords in a **Clockwise** direction and use a cleaning rag in one hand to wipe & dry.

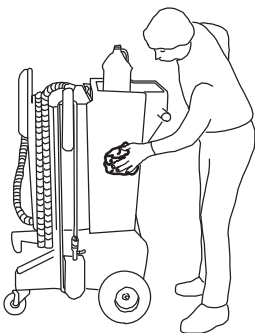

Wipe entire unit clean with an all purpose cleaner. **(DO NOT PRESSURE WASH MACHINE)**

Unscrew locking collar to remove tools

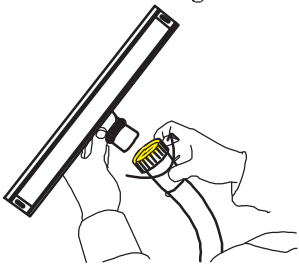

For Floor Squeegee, insure brass ring is located in groove.

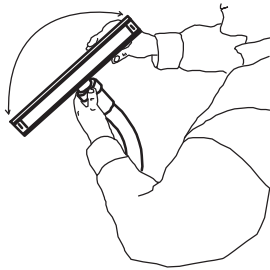

When collar is snug Floor Squeegee should rotate freely.

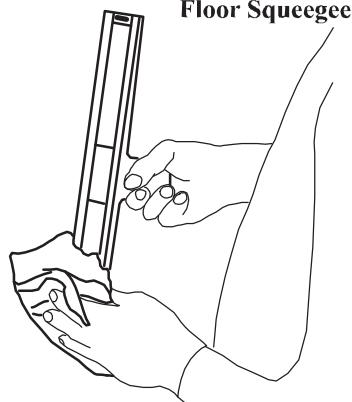

Floor Squeegee

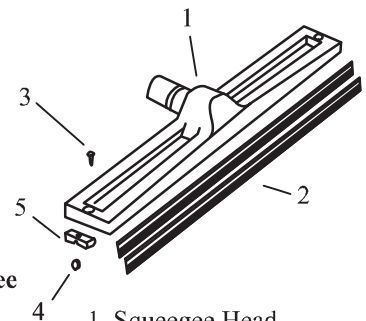

1. Squeegee Head
2. Blades
3. Screw
4. Wheel Holder
5. Wheel

Wipe Squeegee blades with cloth. Inspect tool for worn wheels and blades. Replace as needed.

General Maintenance

Kaivac

Safety

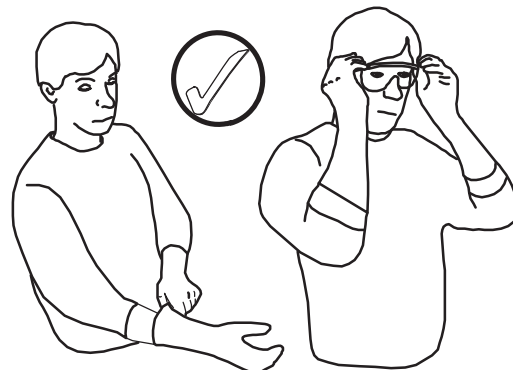
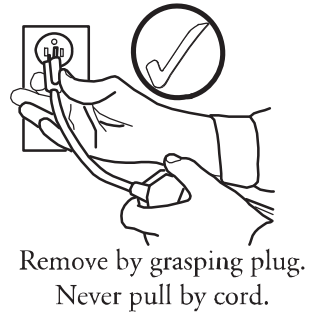
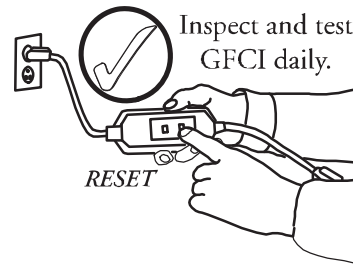
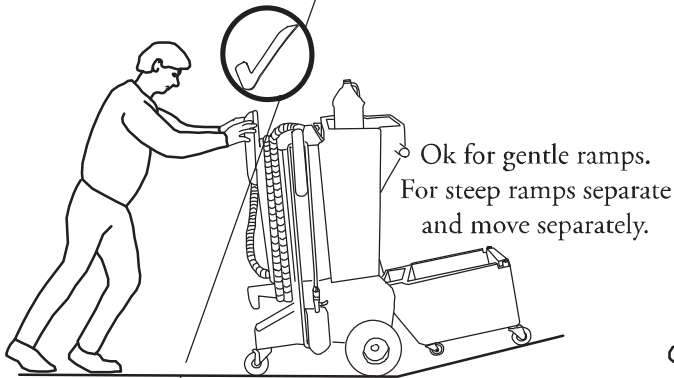
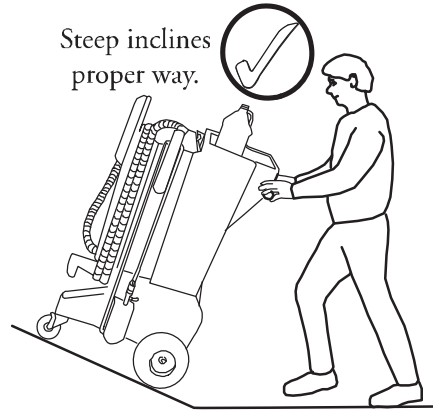

KaiVac Safety

Kaivac

Tool Arrangement

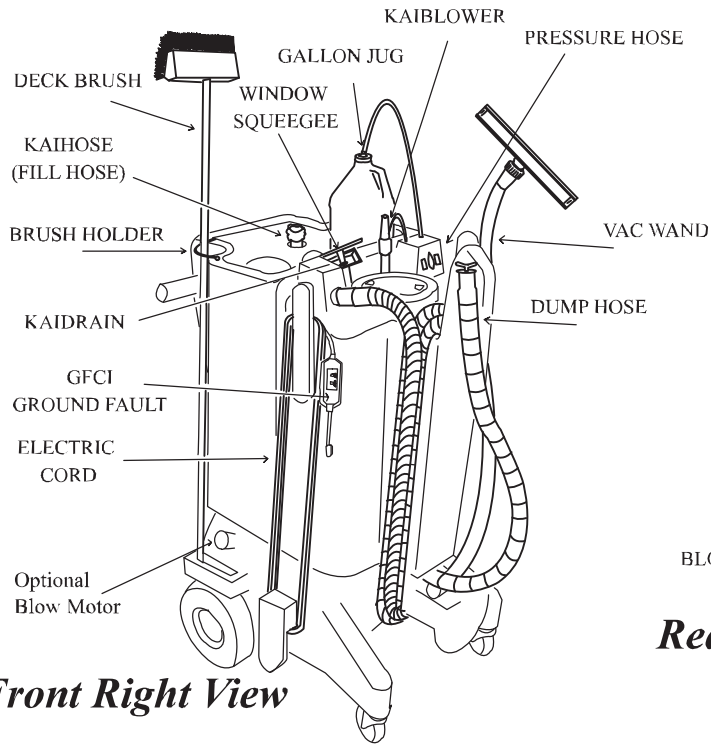

Front Right View

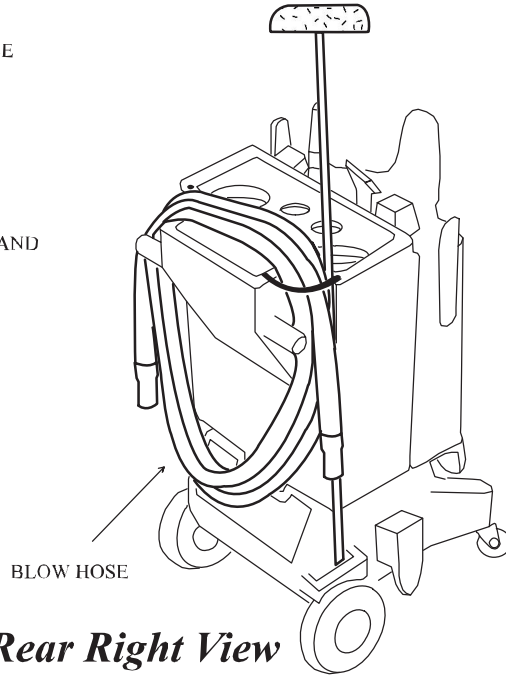

Rear Right View

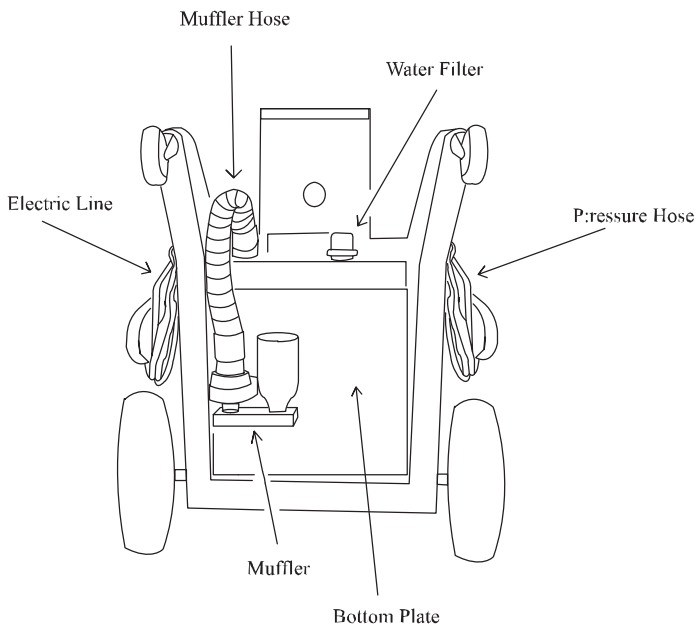

Bottom View

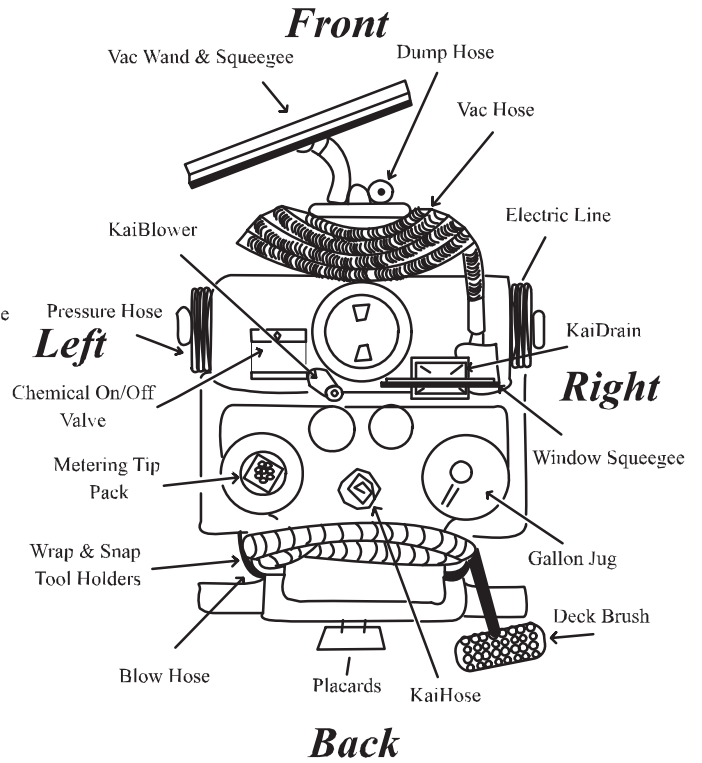

Left

Right

Back

Tool Arrangement

Kaivac Blow Operation

Using Vac Hose (Must Clean & Dry Before Use)

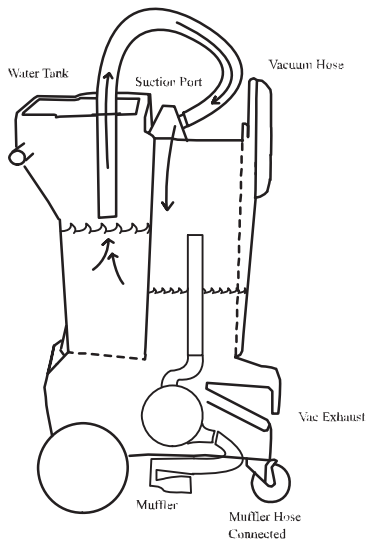

Flush (clean) Vac Hose
Operator inserts hose into water tank for 2-3 seconds

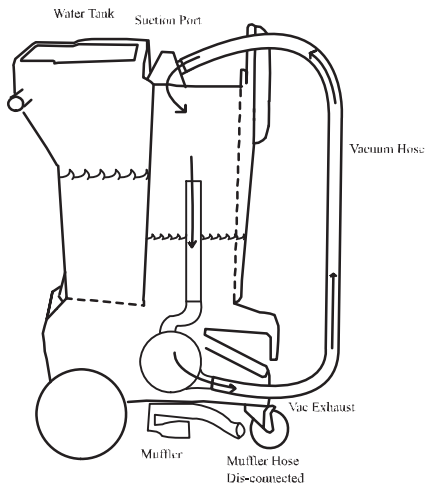

Rinse & Dry out Vac Hose
Operator disconnects muffer hose and connects vac hose to vac motor exhaust, running motor for 3 minutes. Operator disconnects hose at vac suction port and ready for blow operation.
OPTIONAL STEP if blow dry is required

Using Blow Hose

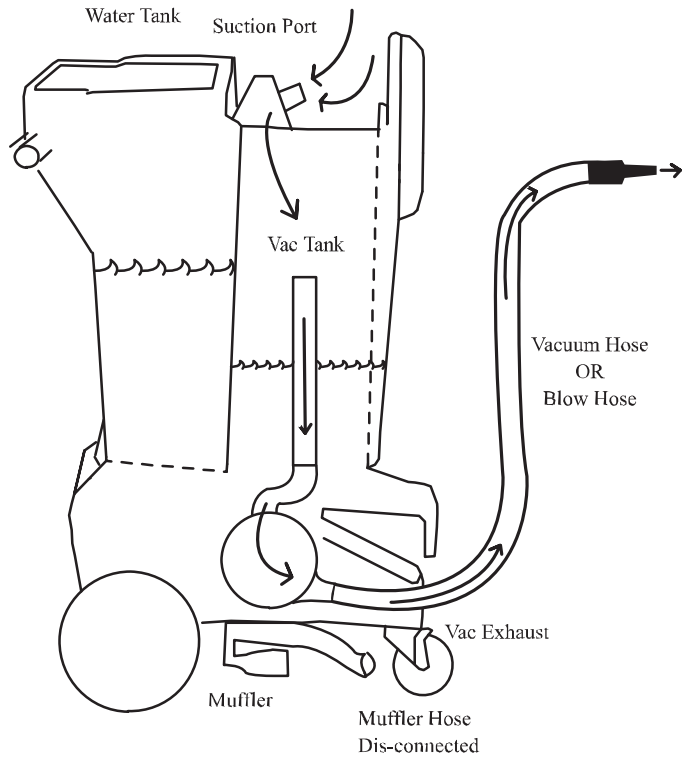

Blow Mode

NOTE- Worker should wear respirator mask for Blow Operation in dusty areas.

Kaivac Optional Uses

Cafeterias and Kitchens

Note: Cover all food and utensils before cleaning

- Deep clean grout lines in quarry tile with the optional KaiMop.
- Tables, chairs and equipment may be pressure washed to remove embedded soil.
- Walls and floors may be cleaned using the S-I-M-P-L-E system.

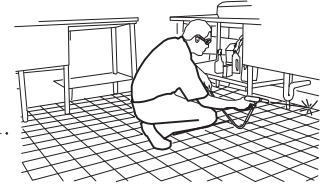

Locker and Shower Rooms

- Blow debris from in and under lockers, overhead fixtures and vents with the blow feature.
- Pressure wash and disinfect inside lockers.
- Use KaiBloey cleaner for delimiting shower rooms via chemical injection system.
- Use S-I-M-P-L-E procedures in other shower and locker room areas.

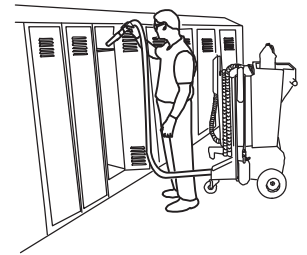

Stripping Floors

- Apply concentrated stripping solution using the chemical injection system. The chemical injection system will allow a 1:8 dilution ratio with no metering tip in place.
- Walk backwards while applying stripper to avoid stepping on wet surfaces.
- Scrub the floor with stripping pads or brushes.
- Wet-vac stripping solution from floor with the KaiVac squeegee tool.
- Use the spray gun and clean water from the water tank to rinse the floor an hard to reach areas as necessary. Turn the chemical valve to the "off" position to rinse the floor with water in low pressure mode.
- Blow the remaining stripper solution from behind baseboards, lockers and other hard to reach areas with the blow dry tool.
- Finally wet-vac rinse solution from the floor and touch up as needed.

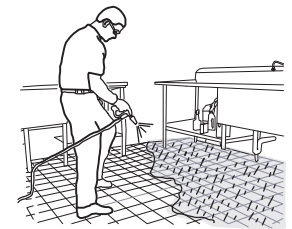

Other Uses

- **High-Dusting** - Use air blast for cobweb and other dusting jobs.
- **Salt and water pickup** - Great for picking up water and salt during winter and rainy seasons.
- **Entrance Mat Cleaning** - Pressure wash and wet vac entry mats.
- **Window Cleaning** - Apply window washing solution with gun, squeegee window and wet vac off floor. Use only on compatible floors and walls.
- **Walls** - Use S-I-M-P-L-E process.
- **Stairwells** - Dust with air blast. Use S-I-M-P-L-E for deep cleaning.

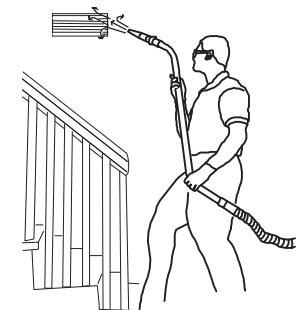

Chemical Injection Chart



METERING TIP CHART

| TIP | PSI | OZ Per Gallon |
|----------|---------|---------------|
| • Black | 300/500 | 1.25 / 2 |
| • Aqua | 300/500 | 3.00 / 4 |
| • Orange | 300/500 | 4.75 / 5 |
| • Tan | 300/500 | 9.50 / 10 |
| • None | 300/500 | 35 / 40 |

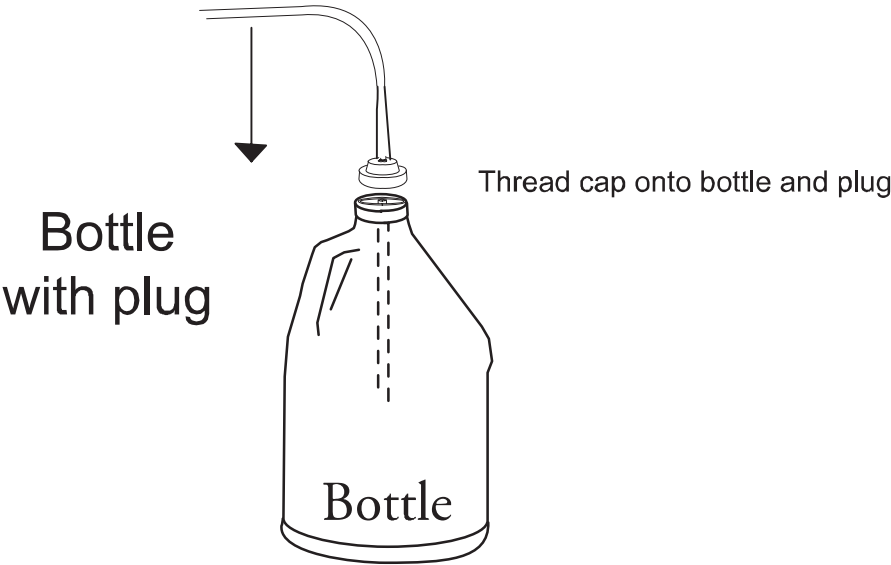
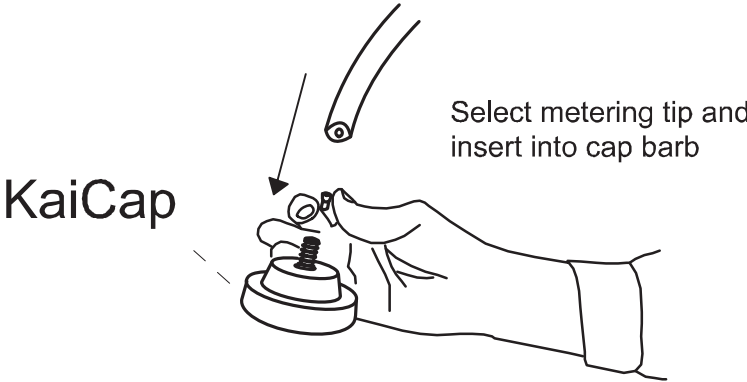

Kaivac Maintenance



CAUTION

Always make sure machine is unplugged before lifting electrical cover assembly

| Item | Procedure |
|--------------------------|---|
| Floor Squeegee | <ul style="list-style-type: none"> * Check condition of rubber squeegee blades and wheels on the floor tool. Rough floor surfaces will cause the blades and wheels to wear out more quickly. Replace as necessary. |
| Spray Gun | <ul style="list-style-type: none"> * Check spray pattern. If spray pattern will not pinpoint, clean orifice by removing it with an Allen wrench and flushing. Replace if not pinpointing. * If nozzle becomes difficult to move from high to low pressure lubricate nozzle with lithium grease. |
| Pressure Hose | <ul style="list-style-type: none"> * Wipe clean after each use. * Check for cuts or frays in the hose jacket, particularly at the end of the fittings. Replace hose if cuts are found. |
| Water Filter | <ul style="list-style-type: none"> * Check filter screens for debris and clean as needed. Be careful not to crush the end of the filter screen when replacing. * Check the clear filter bowl cover to be sure it is tight. * Check for leaks around filter and filter connections. |
| Water Tank | <ul style="list-style-type: none"> * Check condition of filter in water tank. Clean as needed. * Empty the water tank to prevent mildew and bacteria growth. Empty tank by dipping the vacuum hose onto the water tank and transferring the water to the vacuum tank. |
| Vacuum Tank | <ul style="list-style-type: none"> * Empty and flush vacuum tank. * Clean and disinfect. * Check the float shutoff screen to be sure it is not plugged up. A plugged filter screen restricts airflow and results in reduced suction. |
| Leaks | <ul style="list-style-type: none"> * Be alert for leaks around hoses, fittings, spray wand, tanks or elsewhere. Discontinue use until leaks are repaired. |
| Electrical System | <ul style="list-style-type: none"> * The ground fault circuit interrupter (GFCI) must be tested before each use. * Electric cords must be inspected for tears or cuts in the insulation. |
| DVD System | <ul style="list-style-type: none"> * Make sure DVD player is dry and free of any debris placed on top or inside of storage compartment. |

Kaivac Troubleshooting



CAUTION

Always make sure machine is unplugged before removing electrical box or base cover assembly

| Area | Problem | Possible Cause | Remedy |
|-----------------|--------------------------------|--|--|
| Electrical | No power to pump or vac motor. | <ol style="list-style-type: none"> 1. KaiVac not plugged in. 2. Switch not "on". 3. GFCI tripped. 4. Building circuit overloaded. 5. Switch wires loose. 6. Terminal block connections loose. | <ol style="list-style-type: none"> 1. Plug machine in. 2. Check switches for "on". 3. Test and reset GFCI. 4. Check and reset circuit. 5. Disconnect power and check for loose wire. 6. Disconnect power and check for loose wire. |
| | Electrical burning smell | <ol style="list-style-type: none"> 1. Vac motor brushes worn. 2. Vac motor hung up. 3. Pump motor hung up. | <ol style="list-style-type: none"> 1. Replace vac motor brushes. 2. Replace vac motor. 3. Release pressure on hose and jog pump switch. Or replace. |
| Vacuum System | No / Weak vacuum | <ol style="list-style-type: none"> 1. Vac tank full. 2. Squeegee blades or wheels worn. 3. Float-shutoff screen dirty. 4. Float ball stuck. 5. Damaged hose. 6. Dump hose plug missing. 7. Access lid not tight. 8. Vacuum hose plugged. 9. Too much liquid in vac hose. 10. Vac hose still wrapped. 11. Muffler plugged. 12. Hose from vac motor to standpipe loose. 13. Leak in vac tank. | <ol style="list-style-type: none"> 1. Empty vac tank. 2. Replace wheels or blades and check periodically. 3. Spray off float bag to clean. 4. Tap float and release / clean. 5. Cut and repair / replace. 6. Contact dealer and replace. 7. Tighten lid hand tight. 8. Flush hose to remove debris. 9. Allow air in when Vacuuming. 10. Unwrap vac hose fully. 11. Remove padding and clean. 12. Reattach and tighten. 13. If repairable, clean and dry affected area and silicone. |
| | Moister from exhaust | <ol style="list-style-type: none"> 1. Vac tank full. 2. Float-shut off missing. 3. Excessive foam in vac tank. 4. Standpipe leaking. 5. Water sprayed into standpipe while cleaning. | <ol style="list-style-type: none"> 1. Dump vac tank. 2. Replace. 3. Use defoamer. 4. Silicone threads or replace. 5. Use care to avoid spraying directly into float housing. |
| Blow dry system | No air flow | <ol style="list-style-type: none"> 1. Hose disconnected. | <ol style="list-style-type: none"> 1. Reconnect hose. |
| | Moister from nozzle | <ol style="list-style-type: none"> 1. Water in vac hose. | <ol style="list-style-type: none"> 1. Dry vac line. |
| | Suction instead of blow action | <ol style="list-style-type: none"> 1. Vacuum hose connected to tank inlet. | <ol style="list-style-type: none"> 1. Reconnect to vac motor exhaust. |
| | | | |

Kaivac Troubleshooting



CAUTION

Always make sure machine is unplugged before removing electrical box or base cover assembly

| Area | Problem | Possible Cause | Remedy |
|---------------------------|--|---|---|
| High Pressure System | No water from pump or low pressure | <ol style="list-style-type: none"> 1. Out of water. 2. Gun nozzle plugged. 3. Air in pump(vapor lock). 4. Gun orifice missing. 5. Tank filter plugged. 6. Inline filter plugged. 7. Bowl filter lid loose. 8. Pressure hose damaged. 9. Quick disconnect leaking. 10. Injector plugged. 11. Pulse hose damaged. 12. Regulator failed. 13. Hose kinked. 14. Seals in pump need replaced. | <ol style="list-style-type: none"> 1. Fill water tank. 2. Remove orifice with allen wrench and clean. 3. Use power prime technique. 4. Replace orifice. 5. Clean tank and filter. 6. Remove filter cover and clean. 7. Gently tighten bowl cover. 8. Repair or replace. 9. Tighten or replace. 10. Using an airline or equal blow small bursts of air into affected chemical line. 11. Repair or replace. 12. Replace. 13. Unkink and check for damage. 14. Remove and replace seals. |
| | Bad fan pattern or pinpoint pattern on gun | <ol style="list-style-type: none"> 1. Debris in nozzle. 2. Orifice damaged. | <ol style="list-style-type: none"> 1. Remove orifice with allen wrench and clean. 2. Remove and replace. |
| Chemical Injection System | No chemical flow | <ol style="list-style-type: none"> 1. Out of chemical. 2. Chemical line not in jug. 3. Chemical valve in "off". 4. Filter plugged. 5. Spray gun in wrong mode. 6. Metering tip plugged. 7. Injector plugged. 8. Air entering system. 9. Injector installed backwards. | <ol style="list-style-type: none"> 1. Refill chemical. 2. Make sure line is in chemical. 3. Check on off valve. 4. Clean filter. 5. Make sure gun nozzle is pulled out away from gun for chemical mode. 6. Check metering tip for clog. 7. Using an airline or equal. blow small bursts of air into affected chemical line. 8. Check for air entering system around chemical lines or injector. 9. If fluttering or pulsing sound can be heard while spraying or when machine is running it is possible that you injector is in backwards. Remove and reinstall. |

Kaivac Troubleshooting





CAUTION
Always make sure machine is unplugged before removing electrical box or base cover assembly

| Area | Problem | Possible Cause | Remedy |
|---------------------------------|---|---|--|
| Chemical Injection System cont. | Not enough chemical flow | <ol style="list-style-type: none"> 1. Metering tip plugged. 2. Wrong metering tip. | <ol style="list-style-type: none"> 1. Remove and clean. 2. Check and replace per chart. |
| | Chemical line blows off safety cap. Water backflows into chemical bottle | <ol style="list-style-type: none"> 1. Debris in injector. 2. Bad seat on injector valve. 3. Injector installed backwards. | <ol style="list-style-type: none"> 1. Using an airline or equal, blow small bursts of air into affected chemical line. Or remove electric box and clean injector. 2. Check injector o-ring or replace. 3. Remove and reinstall correctly, arrow on injector should point towards pressure hose. |
| Dump System | Tank will not empty | <ol style="list-style-type: none"> 1. Dump hose plug not removed. 2. Drain hose plugged. 3. Dumping area too high for flow. | <ol style="list-style-type: none"> 1. Hold hose high and remove plug, lower and dump. 2. Raise and lower dump hose to agitate. If garden hose is available blow water back through line to remove blockage. 3. Dump into lower area. |
| | Dump hose leaks | <ol style="list-style-type: none"> 1. Hose cut. 2. Clamp loose. 3. Dump plug bushing missing. 4. Plug missing. | <ol style="list-style-type: none"> 1. If leak is less than 4" from tank side, cut and reattach. Or replace. 2. Retighten hose clamp. 3. Replace bushing. 4. Replace plug. |
| Wheels and casters | Wheels won't roll or they rub | <ol style="list-style-type: none"> 1. Flat tires. 2. Debris wrapped around axle. 3. Bearings tight. 4. Wheels too loose on axle. 5. Bearing falling out. | <ol style="list-style-type: none"> 1. Inflate tires to 30 psi. 2. Check for debris on axle. 3. Grease bearings. 4. Remove wheel, add washers to take up slack. 5. Refer to remedy 4. |
| Squeegee Head | Floor streaks | <ol style="list-style-type: none"> 1. Worn blades or wheels. | <ol style="list-style-type: none"> 1. Replace wheels and or blades. |
| | Squeegee head doesn't easily rotate when installed on wand | <ol style="list-style-type: none"> 1. Brass ring on wand not in groove. 2. Coupling nut too tight. | <ol style="list-style-type: none"> 1. Loosen coupling nut and reposition head on groove. 2. Loosen 1/2 turn. |
| | Head won't stay on wand | <ol style="list-style-type: none"> 1. Coupling nut cracked. 2. Brass ring worn. | <ol style="list-style-type: none"> 1. Replace. 2. Replace. |
| | Premature blade wear Sucks to the floor too tightly | <ol style="list-style-type: none"> 1. Squeegee wheels worn. | <ol style="list-style-type: none"> 1. Check wheels for wear/ replace. |

Kaivac Flow Diagram

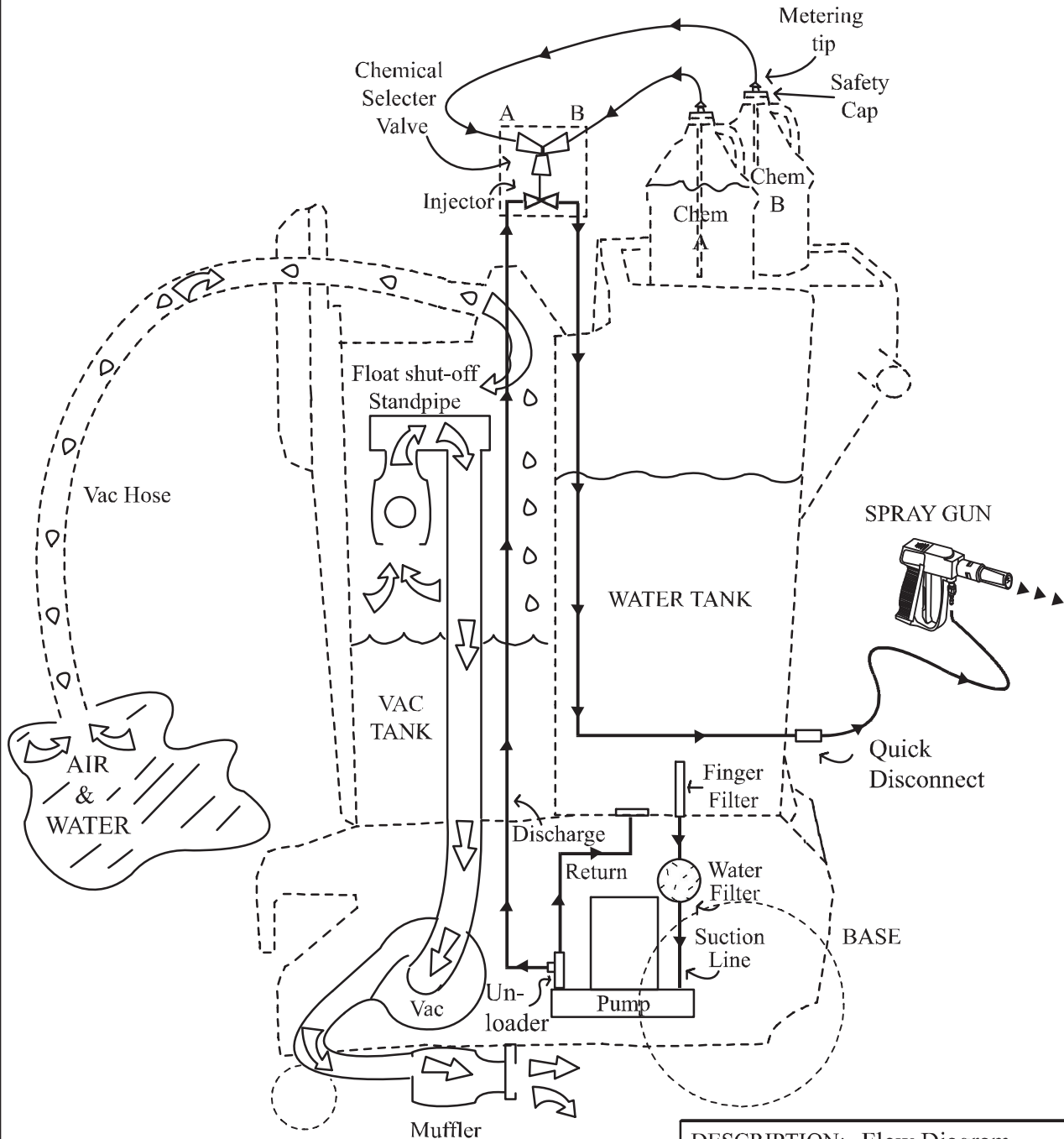
| REVISION | DATE | DESCRIPTION |
|----------|-------|--------------|
| A | 05/01 | Flow Diagram |



| | |
|--|--------------------|
| DESCRIPTION: Flow Diagram | |
|  | Kaivac inc. |
| ISSUE DATE: 01/2001 | REVISION: |

Kaivac Electrical Diagram

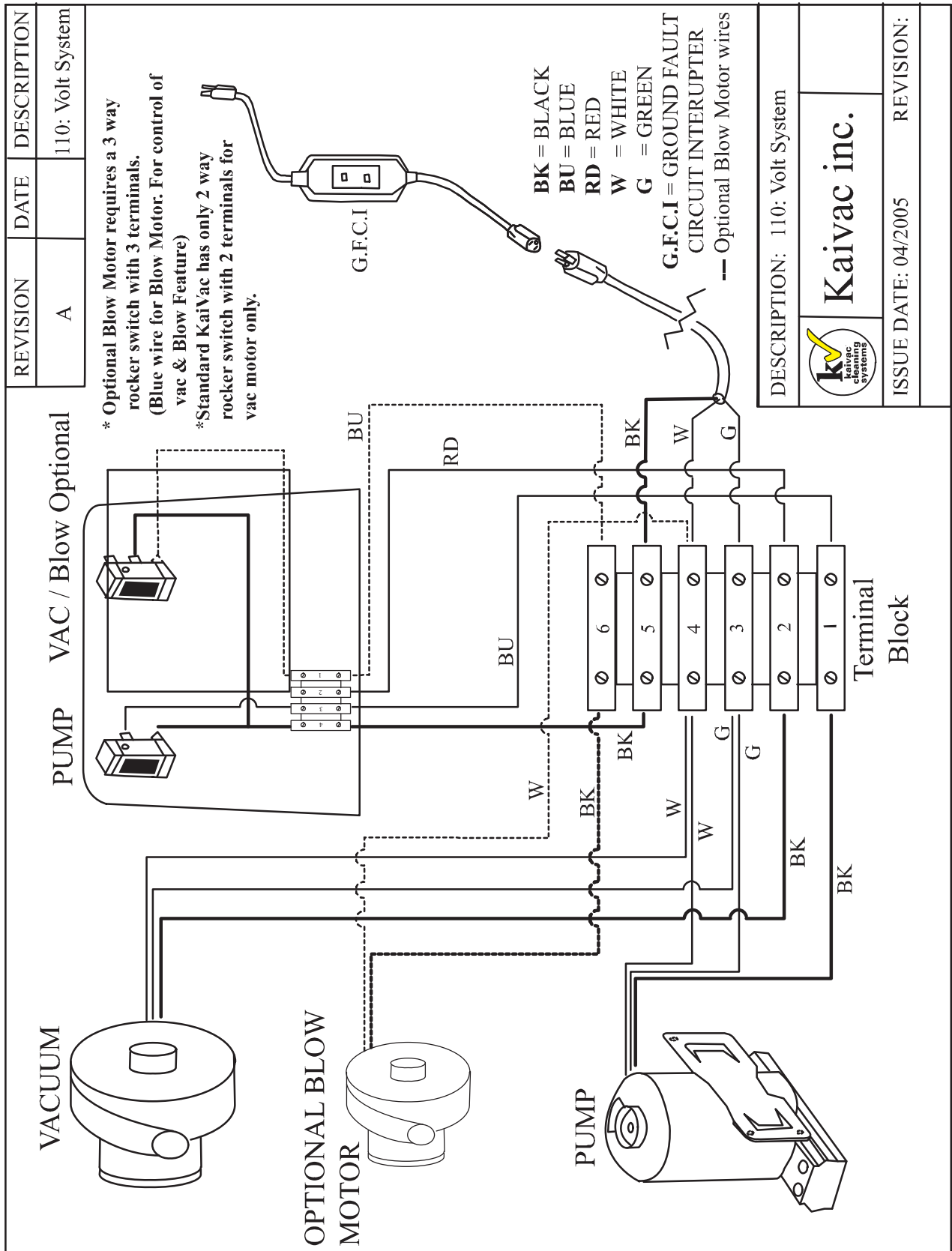

| | |
|-------------------------------|--------------------|
| DESCRIPTION: 110: Volt System | Kaivac inc. |
| | REVISION: |
| ISSUE DATE: 04/2005 | |



SECTION 2

KAIVAC 2001 PARTS LIST BY DRAWING

| DRAWING PART NO. | ITEM NO. | PART DESCRIPTION |
|---------------------|-------------|---------------------------------------|
| | | FIGURE#1 KaiVac External Parts |
| 1 | CAS01A | YELLOW DECK BRUSH |
| 2 | CAA06 | WINDOW SQUEEGEE |
| 3 | CVS13 | BLOW NOZZLE |
| 4 | CAS02A | BRUSH HANDLE |
| 5 | CVS14 | KAIDRAIN |
| 6 | SUBFH | FILL HOSE ASSEMBLY |
| 7 | SUBGA | PRESSURE GUN ASSEMBLY |
| 8 | SUBPH | PRESSURE HOSE ASSEMBLY |
| 9 | SUBEB2001 | ELECTRIC BOX / CHEMICAL LINE ASSEMBLY |
| 10 | CES08 | 1/4 -20 X 4 SCREW FOR ELECTRICAL BOX |
| 11 | CSS11 | #8 SELF DRILLING SCREW |
| 12 | SUBSS | WRAP AND SNAP ASSEMBLY |
| 13 | CSS20 | SNAP STUD |
| 14 | CSS14 | #13 CLAMP FOR VAC WAND |
| 15 | CVS10 | EXPANSION PLUG |
| 16 | CSS17 | #8 X 3/4 L SQUARE DRIVE SCREW |
| 17 | CVS12 | 14 1/2 " VACUUM HEAD SQUEEGEE TOOL |
| 18 | CVS11 | ALUMINUM VACUUM WAND |
| | SUBVW | VAC WAND AND SQUEEGEE HEAD COMPLETE |
| 19 | CES20 | EXTENSION CORD |
| 20 | CES19 | GFCI CORDSET |
| 21 | CFS01C | 10"PNEUMATIC WHEEL W / 5/8 HUB |
| 22 | SUBPCKVAX58 | 5/8 POWDERCOATED AXLE |
| 23 | CSS46 | 5/8 WASHER |
| 24 | CSS43 | 5/8 PUSH CAP NUT |
| 25 | MUFFLER | MUFFLER ASSEMBLY |
| 26 | CSS03 | 1 9/16" - 2 1/2" HOSE CLAMP |
| 27 | CFS08 | BOTTOM COVER |
| 28 | SUBMF | MUFFLER HOSE ASSEMBLY |
| 29 | CFS02 | 4"CASTER |
| 30 | CSS03 | 1 9/16" - 2 1/2" HOSE CLAMP |
| 31 | SUBVH | 33' VAC HOSE ASSEMBLY |
| 32 | CVS06 | CLEAR LID W/ DECK PLATE RING |
| 33 | CSS14 | # 13 CLAMP FOR NOZZLE / GULPER TOOL |
| 34 | CHCAP | SAFETY CAP |
| 35 | CSS12 | # 15 CLAMP FOR DUMP HOSE |
| 36 | PLACARD | INSTRUCTIONAL PLACARDS |
| 37 | SUBBLHS | BLOW HOSE |
| 38 | MTIPS2001 | METERING TIP PACK |
| | CPS46H | ORANGE METERING TIP |
| | CPS47H | AQUA METERING TIP |
| | CPS48H | BLACK METERING TIP |
| | CPS56H | TAN METERING TIP |
| 39 | CEA04 | MALE ELECTRIC PLUG |
| 40 | SUBDH | DUMP HOSE ASSEMBLY |
| | | |
| | | |
| | | |

| DRAWING PART NO. | ITEM NO. | PART DESCRIPTION |
|-----------------------------|-----------------|--|
| | | FIGURE #2 KaiVac Internal Parts |
| 1 | MTIPS2001 | METERING TIP PACK |
| 2 | CHCAP | SAFETY CAP |
| 3 | CPS01 | CHEMICAL LINE (PER FOOT) |
| 4 | SUBEB2001 | ELECTRICAL BOX / CHEMICAL LINE ASSEMBLY |
| 5 | SUBFL | FLOAT SHUT OFF ASSEMBLY |
| 6 | SUBSP | STANDPIPE ASSEMBLY |
| 7 | CES08 | 1/4" 20X4 SCREW |
| 8 | CSS44 | 1/4" FLAT WASHER |
| 9 | CSS27 | 1/4" NYLOC NUT |
| 10 | CVS01 | VAC MOTOR ASSEMBLY |
| 11 | CPS54 | WATER FILTER |
| 12 | SUBVH | VAC MOTOR HOSE ASSEMBLY |
| 13 | CPS15B | HERC HOSE (PER FOOT) |
| 14 | CPS15B | HERC HOSE (PER FOOT) |
| 15 | CPS07 | FINGER FILTER |
| 1 | SUBWH | WATER SUPPLY LINE |
| 17 | SUBWHR | WATER RETURN LINE |
| 18 | CPS14 | PULSE HOSE |
| 19 | CPS39 | 3/8" QUICK DISCONNECT COUPLING |
| 20 | SUBPA | PUMP / MOTOR ASSEMBLY |
| 21 | CPS19 | UNLOADER / CHECK VALVE |
| | | FIGURE#3 14 1/2" SQUEEGEE TOOL |
| 1 | CAA07 | WHEEL |
| 2 | CAA08 | WHEEL HOLDER |
| 3 | CAA09 | HOLDER SCREW |
| 4 | CVS12 | SQUEEGEE HEAD |
| 5 | CVA03 | SQUEEGEE BLADE |
| 6 | CVA16 | TOOL COUPLING |
| 7 | CVA14 | METAL RING |
| 8 | CVA15 | COUPLING NUT |
| | CAA10 | GLIDES (OPTIONAL; REPLACES WHEEL AND WHEEL HOLDER) |
| | | FIGURE#4 SUBEB2001 ELECTRICAL BOX |
| 1 | CES08 | 1/4 X 4" SCREW |
| 2 | CES02B | ROCKER SWITCH |
| 3 | CES09 | SWITCH BOX |
| 4 | CPS68 | 90 DEG 1/8 MALE |
| 5 | CPS50A | 3 WAY CHEMICAL VALVE |
| 6 | CPS01 | CHEMICAL LINE (PER FOOT) |
| 7 | CPS12 | INJECTOR |
| 8 | CES10 | WIRE TERMINAL |
| 9 | CES15 | RED WIRE LEAD |
| 10 | CES16 | BLACK WIRE LEAD |
| 11 | CES17 | BLUE WIRE LEAD |
| 12 | CPS15B | HERC HOSE (PER FOOT) |
| 13 | CPS65 | 1/2" CLAMP |
| 14 | CPS64 | 90 DEG STR ELBOW |
| 15 | CSS21 | SNAP CLAMP |

| DRAWING | | |
|-----------------|-----------------|---|
| PART NO. | ITEM NO. | PART DESCRIPTION |
| | | FIGURE#5 SUBGA GUN ASSEMBLY |
| 1 | CPS16 | SPRAY GUN |
| 2 | CPS23 | 1/4 " QD PLUG |
| 3 | CPA05 | ORIFICE |
| 4 | CPS17 | IDROJET NOZZLE |
| | CPA04 | GUN NOZZLE BEARING |
| 5 | CPS33 | 1/4 CLOSE NIPPLE |
| | | FIGURE#7 SUBFL FLOAT SHUT OFF ASSEMBLY |
| 1 | CVS32 | FLOAT BODY |
| 2 | CVS26 | BALL |
| 3 | CSS63 | TIE WRAP |
| 4 | CVS28 | FILTER BAG |
| 5 | CVS35 | O-RING |
| | | FIGURE#8 STANDPIPE |
| 1 | CVS03 | ADAPTER |
| 2 | CVS04 | PIPE |
| | | FIGURE#9 WATER FILTER |
| 1 | CPS54 | WATER FILTER COMPLETE |
| 2 | BOWL | BOWL COVER |
| 3 | FILTSCREEN | FILTER SCREEN |
| 4 | FILTGASK | BOWL FILTER GASKET |
| | | FIGURE#11 SUBIQD INJECTOR ASSEMBLY |
| 1 | CPS12 | INJECTOR BODY |
| 2 | CPS12B | STAINLESS BALL |
| 3 | CPS62 | VITON O-RING |
| | | (SPRING IS NOT SOLD SEPARATELY) |
| | | FIGURE#12 A SUBPA PUMP MOTOR ASSEMBLY |
| 1 | CSS07 | 5/16 SCREW |
| 2 | CES03 | ELECTRIC WIRE |
| 3 | CPS39 | 3/8 QD COUPLING |
| 4 | CPS14 | PULSE HOSE |
| 5 | CSS08 | U-NUTS |
| 6 | CPS11 | 1/2 HP MOTOR |
| | PUMPSPARE | PUMP HEAD ONLY |
| | | FIGURE#12 B UNLOADER / CHECK VALVE |
| 1 | CPS19 | UNLOADER / CHECK VALVE |
| | | FIGURE#13 CARPET EXTRACTOR |
| 1 | CPS33 | 1/4 CLOSE NIPPLE |
| 2 | CPS23 | 1/4 QD PLUG |
| | | |
| | | |
| | | |
| | | |
| | | |
| | | |
| | | |
| | | |
| | | |
| | | |
| | | |
| | | |

| DRAWING | | |
|-----------------|-----------------|--|
| PART NO. | ITEM NO. | PART DESCRIPTION |
| | | FIGURE#14 KAIGROUTER TOOL |
| 1 | CVS12 | SQUEEGEE |
| 2 | KMOP01 | SPRAY NOZZLE |
| 3 | CPS41A | 3 WAY VALVE |
| 4 | GTS01 | BRASS V JET |
| 5 | CPS71 | 90 DEG ELBOW |
| 6 | MISC | CLEAR SLEAVE |
| 7 | CSS107 | SCREWS |
| 7A | CSS102 | ACORN NUTS |
| 7B | GTS01 | BRASS V JET |
| 8 | CVS11 | VAC WAND |
| 9 | CPS15A | PRESS. HOSE |
| 10 | CSS64 | TIE WRAP |
| 11 | GTS03W | HANGER |
| 12 | CPA09 | VALVE |
| 13 | CPS33 | 1/4 NIPPLE |
| 14 | CPS23 | 1/4 QD PLUG |
| 15 | CPS37 | HOSE GUARD |
| 16 | CPS34 | FERRULE |
| 17 | CPS36 | 1/4 HOSE BARB |
| | | FIGURE#15 SUBUT UPHOLSTERY TOOL |
| 1 | CPS33 | 1/4 CLOSE NIPPLE |
| 2 | CPS23 | 1/4 QD PLUG |
| | | FIGURE#16 MUFFLER |
| 1 | CVS32 | BODY |
| 2 | MUFPAD | SOUND PADDING |
| 3 | CSS39 | HOSE CLAMP |
| 4 | MISC | 2X2 MUFFLER PAD |
| | | MISCELLANEOUS |
| | | TANKS |
| | SUBVT | VACUUM (RECOVERY) TANK |
| | SUBWT | WATER TANK |
| | | HOSE |
| | CVS09A | VACUUM HOSE (PER FOOT) |
| | CVS08A | VACUUM HOSE CUFFS |
| | CVA19 | CONNECTOR FOR VACUUM HOSE |
| | VACHOSE50 | 50 FT. VACUUM HOSE COMPLETE |
| | | PUMP RE-BUILD KITS |
| | PKITA | PUMP KIT A -PLUNGER, SEALS, PISTON |
| | PKITB | PUMP KIT B-VALVES & O-RINGS |
| | PKITC | CAM BEARING |
| | PUMPKIT | PUMP KIT COMPLETE (A,B,C) |

Kaivac External View

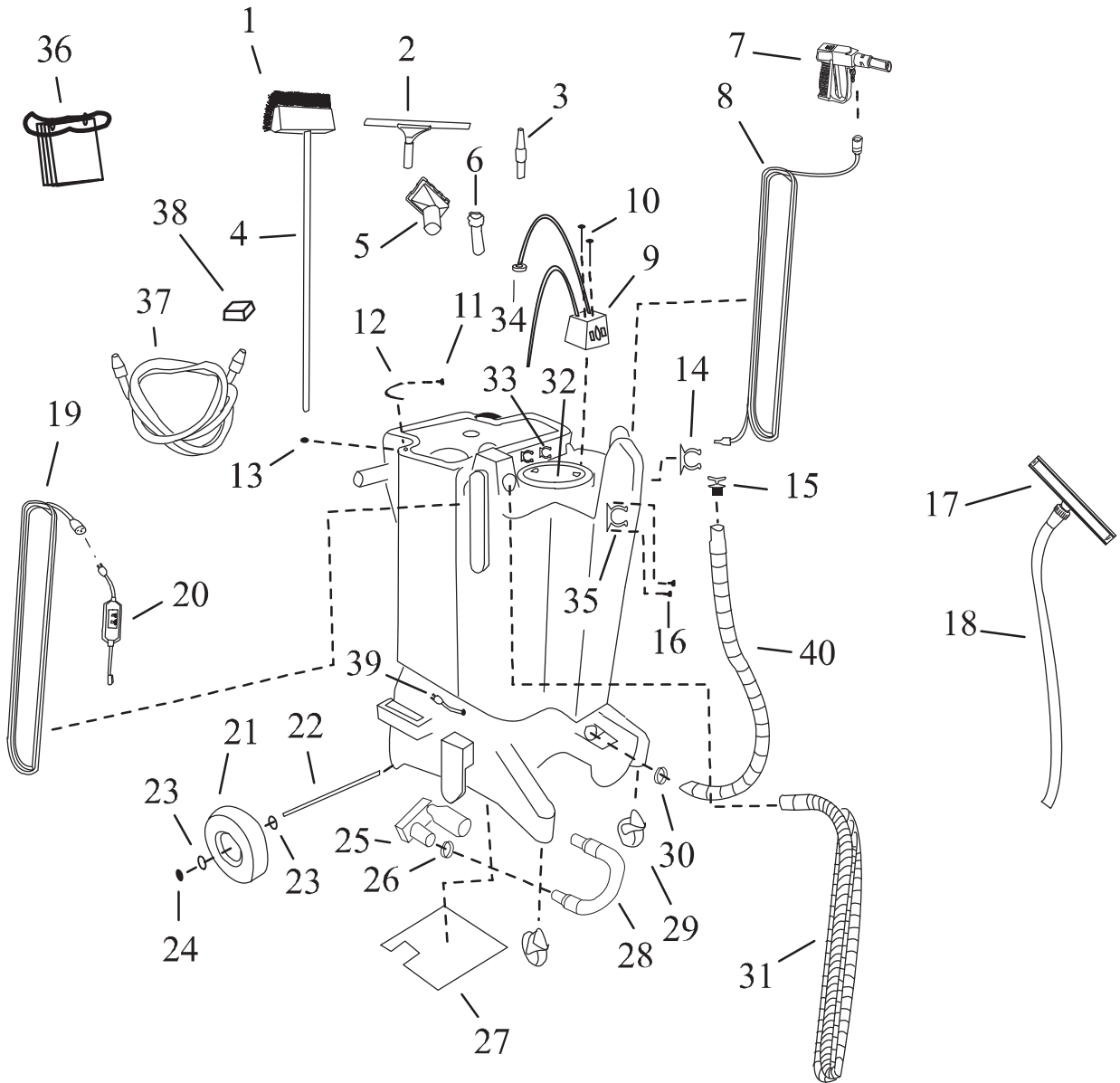

See page 1 SECTION 2
for parts listings

DESCRIPTION: KaiVac External Parts
Serial # 3004 and Higher



Kaivac inc.

ISSUE DATE: 01/2001 REVISION: A

Figure # 1 page 6

Kaivac Internal View

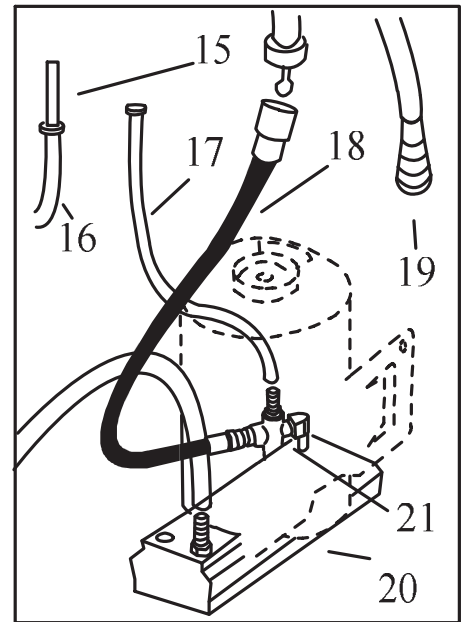
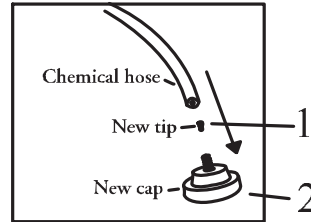
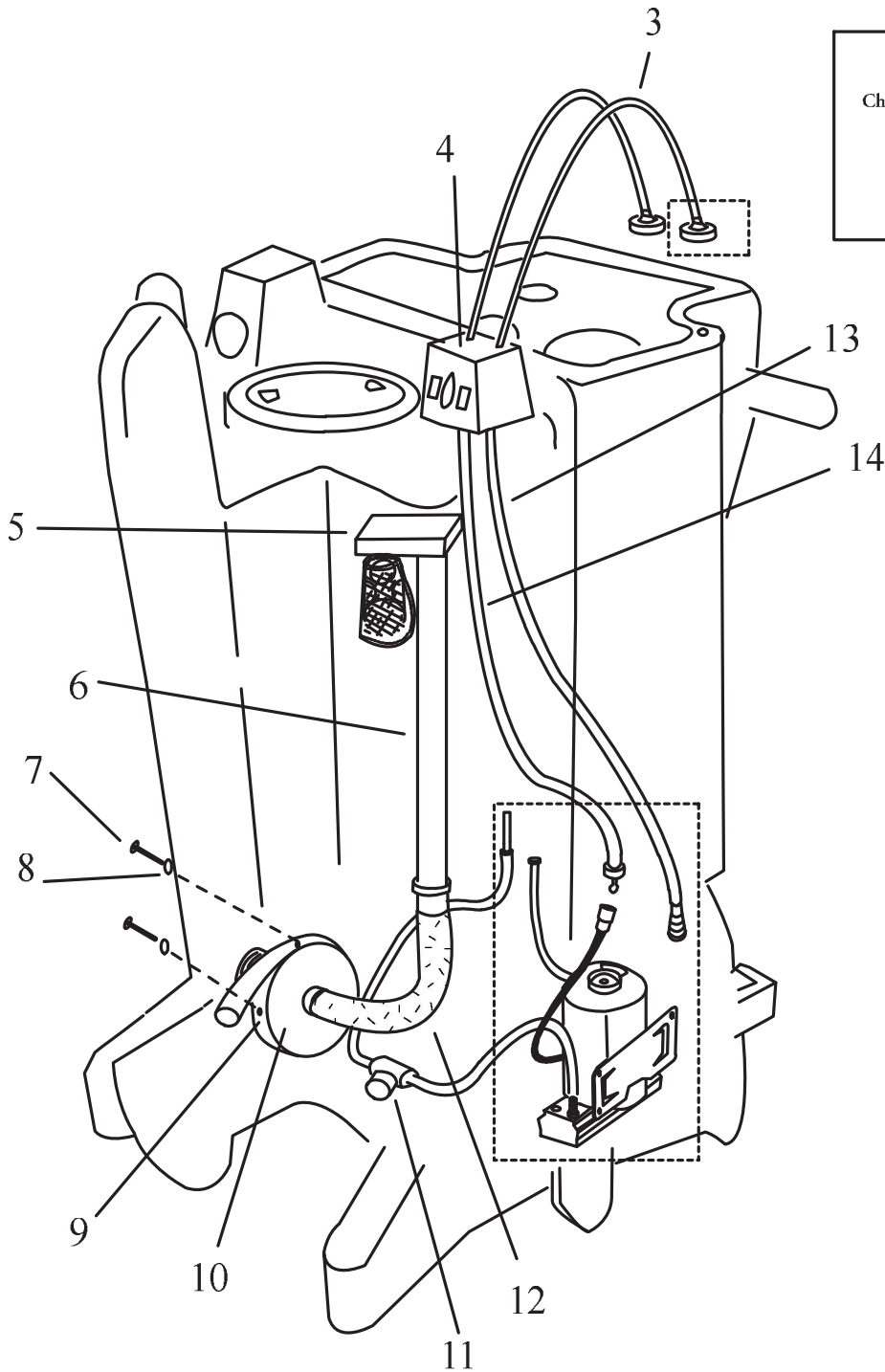

See page 2 SECTION 2
for parts listings

| | | |
|--|--------------------|--|
| DESCRIPTION: KaiVac Internal Parts Serial # 3004 and Higher | | |
|  | Kaivac inc. | |
| ISSUE DATE: 04/2005 | REVISION: A | |
| Figure # 2 | page 7 | |

Kaivac Squeegee / Electric Box

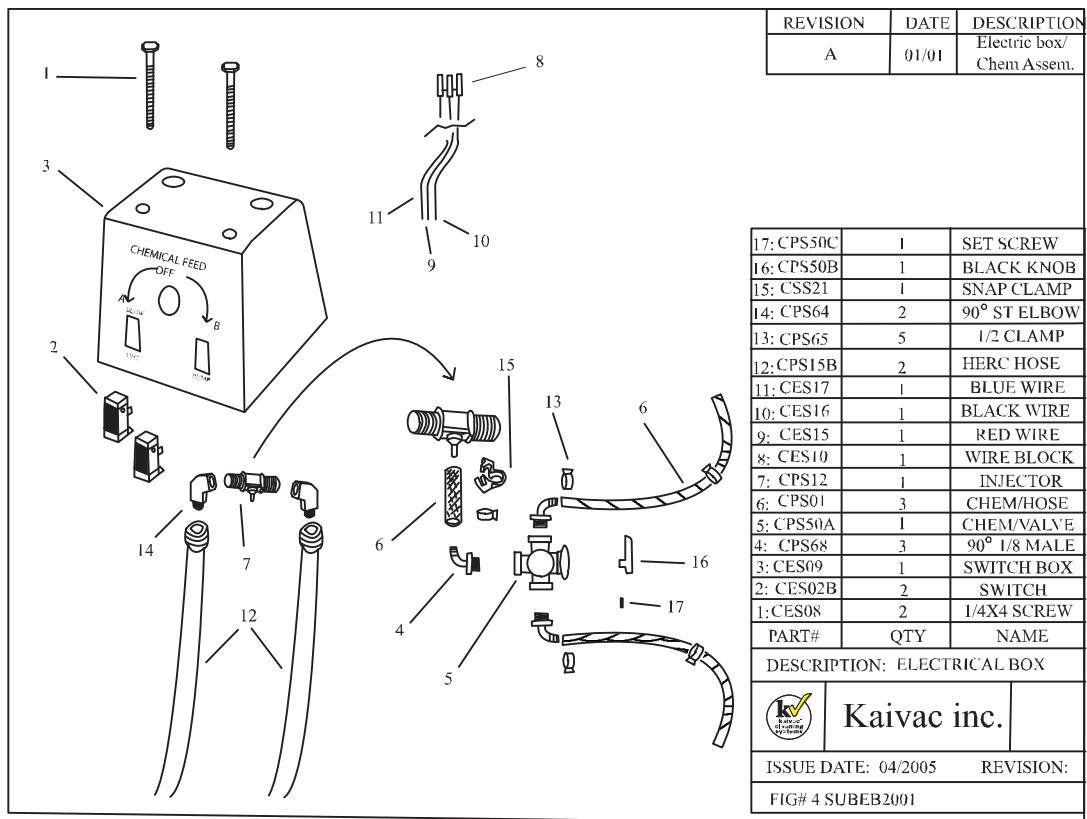
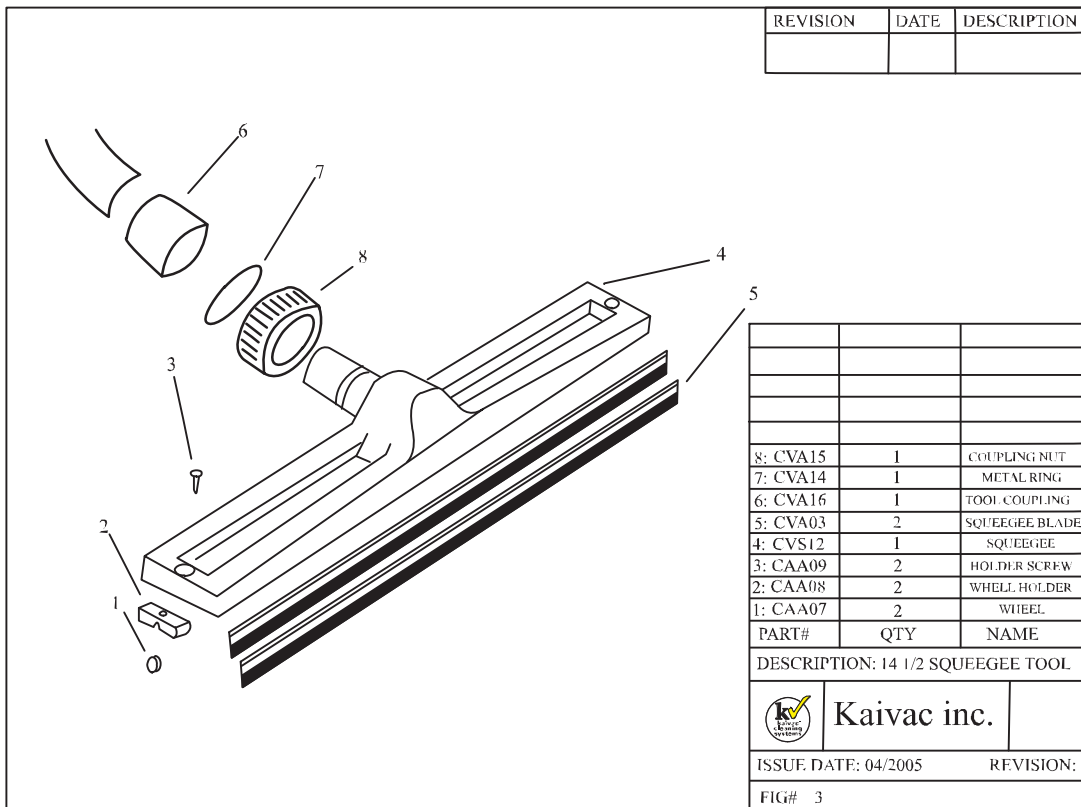

Kaivac Carpet/Grout tool

| REVISION | DATE | DESCRIPTION |
|----------|------|-------------|
| | | |

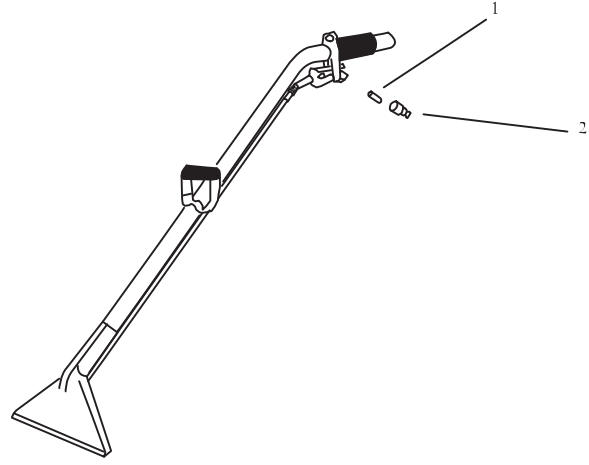

| PART# | QTY | NAME |
|---------|-----|----------------|
| 2:CPS23 | 1 | 1/4 OD PLUG |
| 1:CPS33 | 2 | 1/4 CLOSE NIP. |

DESCRIPTION: CARPET EXTRACTOR

Kaivac inc.
 ISSUE DATE: 04/2005 REVISION:
 FIG# 13 SUBCE

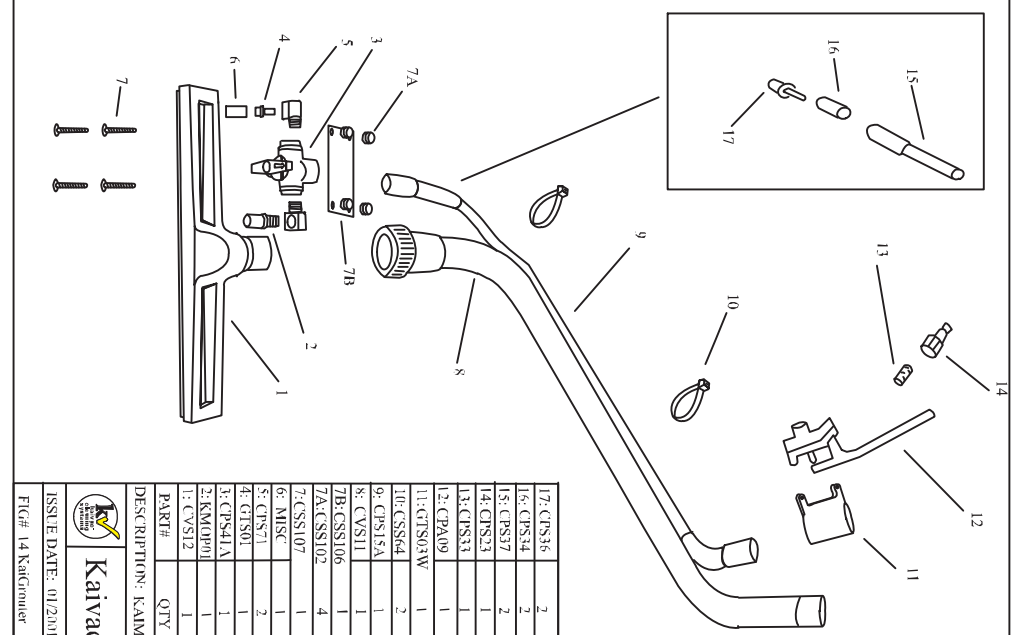

| | | |
|------------|---|---------------|
| 17: CPS36 | 2 | 1/4 HOSE BARB |
| 16: CPS34 | 2 | FERRULE |
| 15: CPS37 | 2 | MESH GRABER |
| 14: CPS23 | 1 | 1/4 OD PLUG |
| 13: CPS33 | 1 | 1/4 NIPPLE |
| 12: CPA09 | 1 | VALVE |
| 11: CTS03W | 1 | 11.5MM BR |
| 10: CSS64 | 2 | TL WRAP |
| 9: CPS15A | 1 | PROSS HOSE |
| 8: CVS11 | 1 | VAC WAND |
| 7B: CSS106 | 1 | MOUNT PLATE |
| 7A: CSS102 | 4 | ACORN NUTS |
| 7: CSS107 | 1 | SCREWS |
| 6: MISC | 1 | CLEAR SLAVE |
| 5: CPS71 | 2 | 3/16" GLENDOW |
| 4: QTS01 | 1 | NOZZLE |
| 3: CPS41A | 1 | 3 WAY VALVE |
| 2: KM0P01 | 1 | NOZZLE |
| 1: CVS12 | 1 | SPLITTER |

| PART# | QTY | NAME |
|--------------------|-----|------|
| DESCRIPTION: KAMOP | | |
| Kaivac inc. | | |

ISSUE DATE: 01/2001 REVISION: 1/6/2001
 FIG# 14 KaiGrinner SHEET 1 OF 1

